

JVC



COMPACT COMPONENT MD SYSTEM

CA-MD9R



COMPACT
disc
DIGITAL AUDIO



INSTRUCTIONS

For Customer Use:

Enter below the Model No. and Serial No. which are located either on the rear, bottom or side of the cabinet. Retain this information for future reference.

Model No. _____

Serial No. _____

LET0070-002A

IMPORTANT for the U.K.

DO NOT cut off the mains plug from this equipment. If the plug fitted is not suitable for the power points in your home or the cable is too short to reach a power point, then obtain an appropriate safety approved extension lead or consult your dealer.

BE SURE to replace the fuse only with an identical approved type, as originally fitted.

If nonetheless the mains plug is cut off ensure to remove the fuse and dispose of the plug immediately, to avoid a possible shock hazard by inadvertent connection to the mains supply.

If this product is not supplied fitted with a mains plug then follow the instructions given below:

IMPORTANT:

DO NOT make any connection to the terminal which is marked with the letter E or by the safety earth symbol or coloured green or green-and-yellow.

The wires in the mains lead on this product are coloured in accordance with the following code:

Blue : Neutral
Brown : Live

As these colours may not correspond with the coloured markings identifying the terminals in your plug proceed as follows:

The wire which is coloured blue must be connected to the terminal which is marked with the letter N or coloured black.

The wire which is coloured brown must be connected to the terminal which is marked with the letter L or coloured red.

IF IN DOUBT - CONSULT A COMPETENT ELECTRICIAN.

Caution — ⚡/| switch!

Disconnect the mains plug to shut the power off completely. The ⚡/| switch in any position does not disconnect the mains line. The power can be remote controlled.

CAUTION

To reduce the risk of electrical shocks, fire, etc.:

1. Do not remove screws, covers or cabinet.
2. Do not expose this appliance to rain or moisture.

REPRODUCTION OF LABELS

- ① CLASSIFICATION LABEL, PLACED ON REAR ENCLOSURE

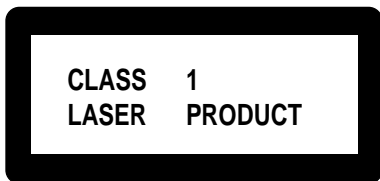

- ② WARNING LABEL, PLACED INSIDE THE UNIT

<p>DANGER: Invisible laser radiation when open and interlock failed or defeated. AVOID DIRECT EXPOSURE TO BEAM. (e)</p>	<p>WARNING: Osynlig laserstrålning när denna del är öppnad och spärren är urkopplad. Betrakta ej strålen. (s)</p>	<p>ADVARSEL: Usynlig laserstrålning ved åbning, når sikkerhedsafbrydere er ude af funktion. Undgå udsættelse for stråling (d)</p>	<p>VARO: Avattaessa ja suojalukitus ohitettaessa olet alttiina näkymättömälle lasersäteilylle. Älä katso säteeseen. (f)</p>
--	--	--	--

1. CLASS 1 LASER PRODUCT
2. **DANGER:** Invisible laser radiation when open and interlock failed or defeated. Avoid direct exposure to beam.
3. **CAUTION:** Do not open the top cover. There are no user serviceable parts inside the Unit; leave all servicing to qualified service personnel.

Caution: Proper Ventilation

To avoid risk of electric shock and fire, and to prevent damage, locate the apparatus as follows:

- 1 Front:
 - No obstructions and open spacing.
- 2 Sides/ Top/ Back:
 - No obstructions should be placed in the areas shown by the dimensions below.
- 3 Bottom:
 - Place on the level surface. Maintain an adequate air path for ventilation by placing on a stand with a height of 10 cm or more.

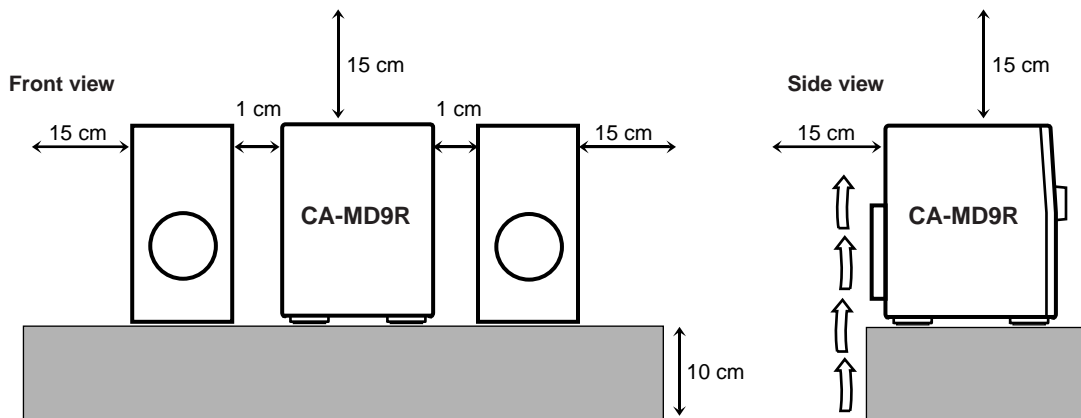

Thank you for purchasing the JVC Compact Component MD System.
Be sure to read this instruction manual carefully before operating your new stereo system.
For questions that are not be answered in the manual, contact your dealer.

Features

Here are some of the things that make your CA-MD9R powerful and easy to use.

- The controls and operations have been redesigned to make them very easy to use so you can spend your time listening to music.
- One Touch Operation**
- With the One Touch Operation feature of JVC's you can turn on the CA-MD9R and start the radio, the Cassette Deck, the CD Player, or the MD Recorder with a single touch.
 - You can use the MULTI JOG dial to set the CD Player, MD Recorder, Tuner, Timer, and Sound Mode operations.
-  CA-MD9R is compatible with RDS (Radio Data System) broadcasting.
- The EON data enables you to standby for information you want.
 - The PTY Search function looks for programs in the category you want.
- In addition, Radio Text can be displayed using data sent by station.
- 3CD Triple Tray** 3-Tray CD Player can operate 3 CDs.
- CDs can be changed during play.
 - Continuous, random or program play of 3 CDs.
- 3MD Changer** 3-MD changer can operate 3 MDs.
- MDs can be changed during play.
 - Continuous, random or program play of 3 MDs.
 - Digital recording from CD to MD.
 - Easy editing of your favorite songs with the powerful editing functions of your CA-MD9R.
- Three timers** The three timers, **Daily Timer**, **Recording Timer**, and **Sleep Timer** are extremely easy to set.

How This Manual Is Organized

In this manual we have incorporated some special features:

- Basic information that is the same for many different functions is grouped in one place, and not repeated in each procedure. For instance, in the section on playing a CD, we do not repeat the information about setting the volume and the sound conditions, which are discussed in the Using the Amplifier section.
- Name of buttons and controls are written in all capital letters like this: SOUND MODE.

IMPORTANT CAUTIONS

1. Installation of the unit

- Select a place which is level, dry and neither too hot nor too cold. (Between 5°C and 35°C or 41°F and 95°F)
- Leave sufficient distance between the unit and a TV.
- Do not use the unit in a place subject to vibrations.

2. Power cord

- Do not handle the power cord with wet hands!
- Some power (15 watts) is always consumed as long as the power cord is connected to the wall outlet.
- When unplugging the unit from the wall outlet, always pull the plug, not the power cord.

3. Malfunctions, etc.

- There are no user-serviceable parts inside. If anything goes wrong, unplug the power cord and consult your dealer.
- Do not insert any metallic object into the unit.

Table of Contents

Features	1	Using the MD Recorder (Editing)	41
How This Manual Is Organized	1	DIVIDE Function	42
IMPORTANT CAUTIONS	1	JOIN Function	44
Getting Started	3	MOVE Function	45
Accessories	3	ERASE Function	47
How to Put Batteries in the Remote Control	3	ALL ERASE Function	48
Using the Remote Control	3	TITLE Function	49
Connecting the FM Antenna	4	Using the Cassette Deck (Playing)	51
Connecting the AM (MW/LW) Antenna	4	Regular Play	52
Connecting the Speakers	5	Music Scan	53
Connecting an External Component	5	Other Useful Features of the Cassette Deck	53
Demo Mode	6	Using the Cassette Deck (Recording)	54
One Touch Operation	6	Standard Recording	55
Using the Amplifier	7	CD Direct Recording	56
Turning the Power On and Off	7	Using the Timers	57
Adjusting the Volume	8	Setting the Clock	57
Reinforcing the Bass Sound	8	Setting the Daily Timer	59
Sound Modes	9	Setting the Recording Timer	62
Using an External Component	10	Setting the Sleep Timer	64
Using the Tuner	11	Timer Priority	65
Tuning in a Station	11	Disc Lock Function	66
Presetting Stations	12	Care and Maintenance	67
Changing the FM Reception Mode	13	Troubleshooting	68
Receiving FM Stations with RDS	13	MD Error Messages	69
Using the CD Player	18	Specifications	70
Using the CD Player	19	Additional Informations	71
Programing the Playing Order of the Tracks	21	Some Words about MDs	71
Random Play	24	ATRAC (Adaptive TRansform Acoustic Coding) ..	71
Repeating a Selection or CDs	24	UTOC (User Table Of Contents)	71
Using the MD Recorder (Playing)	25	Serial Copy Management System (SCMS)	72
Using the MD Recorder	26	Sound Skip Guard Memory	72
Programing the Playing Order of the Tracks	28		
Random Play	31		
Repeating a Selection or MDs	31		
Using the MD Recorder (Recording)	32		
Standard Recording	34		
Long Recording (LONG REC)	35		
One Touch CD Recording (CD REC)	36		
Three CD Recording (TRIPLE REC)	37		
Listening Edit Recording (LISTENING)	38		
First Track Recording (1ST TRACK REC)	40		

Getting Started

Accessories

Check that you have all of the following items, which are supplied with the CA-MD9R.

- AM (MW/LW) Loop Antenna (1)
- Remote Control (1)
- Batteries (2)
- FM Antenna (1)

If any of these items is missing, contact your dealer immediately.

How to Put Batteries in the Remote Control

Match the polarity (+ and -) on the batteries with the + and - markings in the battery compartment.

R6P (SUM-3)/AA (15F)

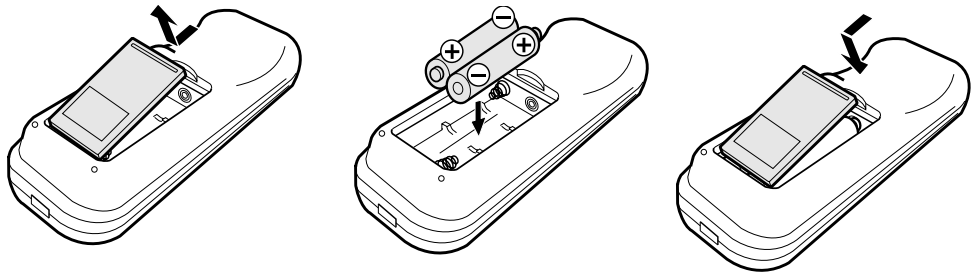

CAUTION: Handle batteries properly.

To avoid battery leakage or explosion:

- Remove batteries when the Remote Control will not be used for a long time.
- When you need to replace the batteries, replace both batteries at the same time.
- Do not use an old battery with a new one.
- Do not use different types of batteries together.

Using the Remote Control

The Remote Control makes it easy to use many of the functions of the CA-MD9R from a distance of up to 7 m (23 feet) away.

You need to point the Remote Control at the remote sensor on the CA-MD9R.

IMPORTANT: Before using the Remote Control for operating this unit, **make sure that the Remote Control is set to the correct operation mode.**

Remote sensor

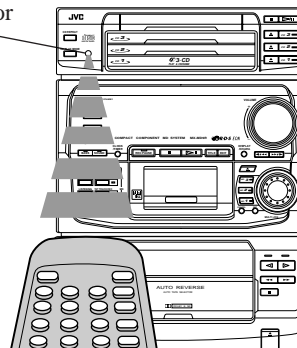

CAUTION: Make all connections before plugging the unit into an AC power outlet.

Connecting the FM Antenna

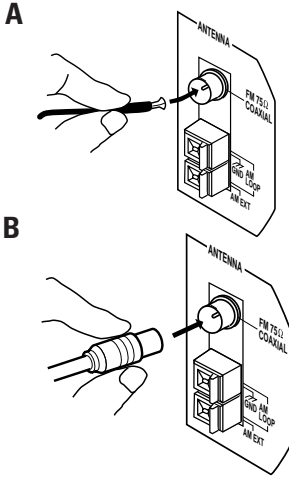

A. Using the Supplied FM Antenna

The FM antenna provided can be connected to the FM 75Ω COAXIAL terminal as temporary measure.

Extend the supplied FM antenna horizontally.

B. Using the Coaxial Type Connector (Not Supplied)

A 75Ω antenna with coaxial type connector (DIN 45332) should be connected to the FM 75Ω COAXIAL terminal.

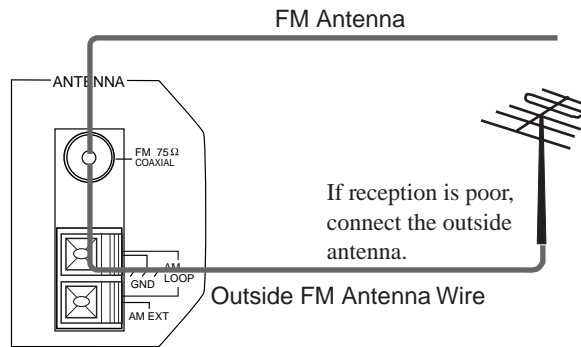

Before attaching a 75 ohm coaxial lead (the kind with a round wire going to an outside antenna), disconnect the supplied FM antenna.

CAUTION: To avoid noise, keep antennas away from metallic parts of the CA-MD9R, connecting cord and the AC power cord.

Connecting the AM (MW/LW) Antenna

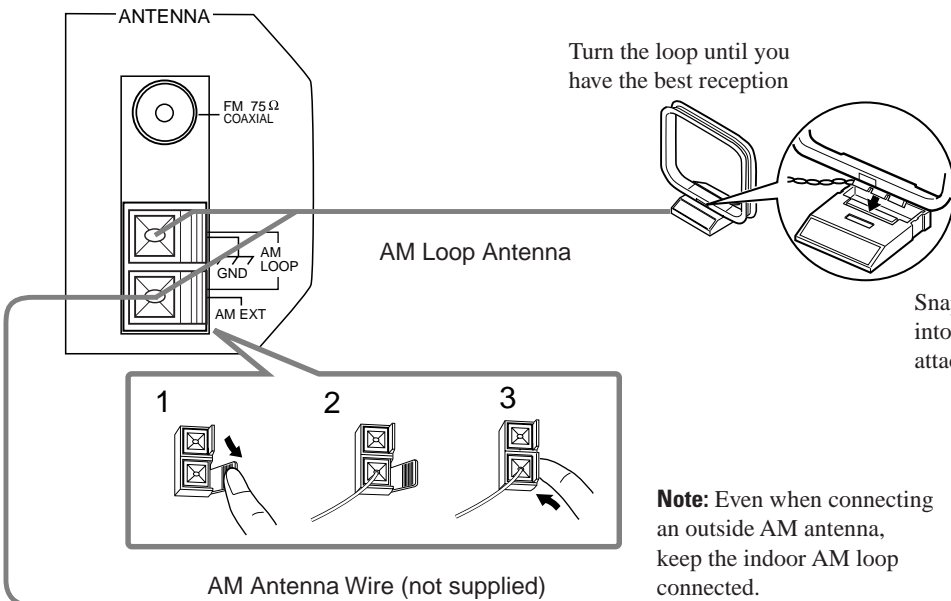

If reception is poor, connect the outside antenna.

CAUTION: Make all connections before plugging the unit into an AC power outlet.

Connecting the Speakers *(Refer to instructions for speakers as well.)*

For each speaker, connect one end of the speaker wire to the speaker terminals on the back of the CA-MD9R and the other end to the speaker.

1. Open the terminals and insert the speaker wires firmly (be sure to remove the insulation at the ends of each wire first), then close the terminals.
2. Connect the red (+) and black (-) terminals of the right side speaker to the red (+) and black (-) terminals marked RIGHT on the CA-MD9R.
Connect the red (+) and black (-) terminals of the left side speaker to the red (+) and black (-) terminals marked LEFT on the CA-MD9R.

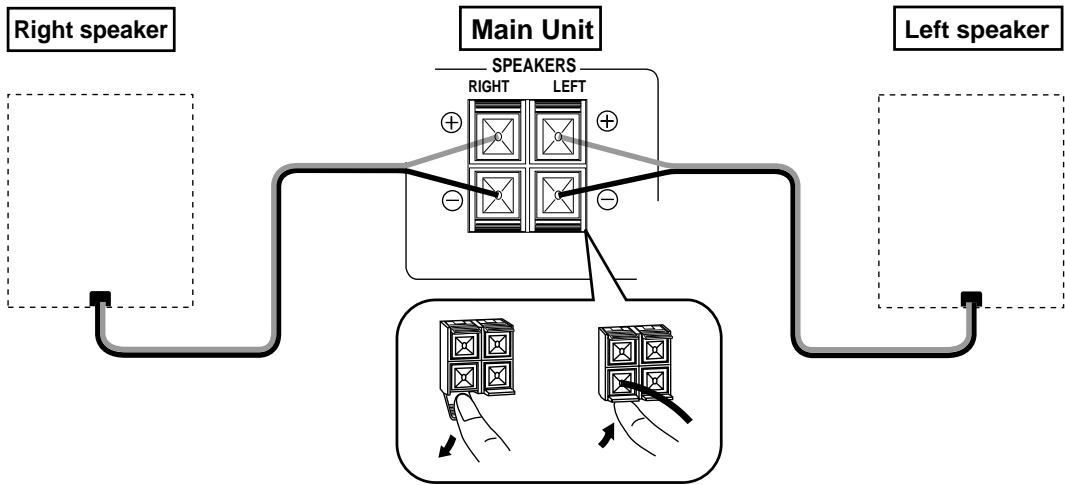

IMPORTANT: Use speakers with the correct impedance only. The correct impedance is indicated on the back panel.

CAUTION: If a TV is installed near the speakers, the picture on the TV may be distorted. If this happens, place the speakers away from the TV.

Connecting an External Component

You can connect another component to the AUX jacks, and reproduce the sound of the component through the CA-MD9R.

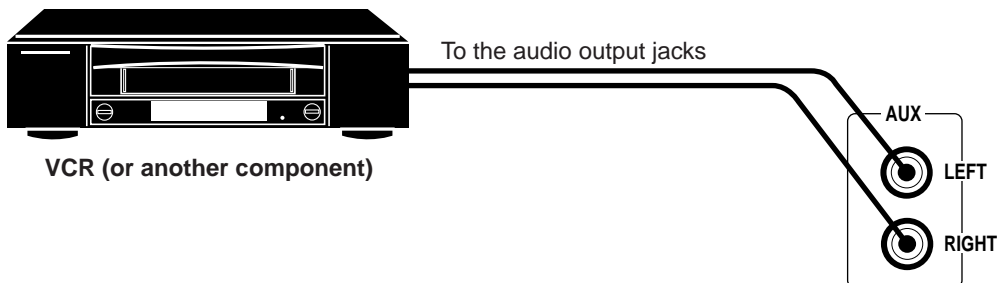

Note: When you connect a VCR to the CA-MD9R, connect the VCR and the TV directly using the video cords to watch a video tape or record a TV program.

Demo Mode

When the CA-MD9R is connected to an AC power outlet, a Demo automatically starts showing some of the main features.



To stop the Demo, press any button.

“DEMO OFF” appears on the display and the Demo stops.

DEMO OFF

To restart the Demo, press the DEMO button.

One Touch Operation

One Touch Operation is JVC's feature that lets you control the most frequently used functions of the CA-MD9R with a single touch.

One Touch Operation starts playing a CD or a MD, turns on the radio, plays a tape, etc. with a single press of the play button for that source. What One Touch Operation does for you is to turn the power on, then start the source you have specified. If the unit is not ready, such as no CD or tape in place, the unit still powers on so you can insert a CD or tape.

How One Touch Operation works in each case is explained in each related section.

The One Touch Operation buttons are:

On the unit

CD (1 to 3) button

CD Player ▷/|| button

▲ (open/close) button for the CD Player

TUNER button

AUX button

MD (1 to 3) buttons

MD Recorder ▷/|| button

▲ (open/close) button for the MD Recorder

</> (Tape play) buttons

On the Remote Control

TUNER button

AUX button

Play button (▶) (when TAPE, CD or MD is selected on the Remote Control)

DISC (1 to 3) (when CD or MD is selected on the Remote Control)

Using the Amplifier

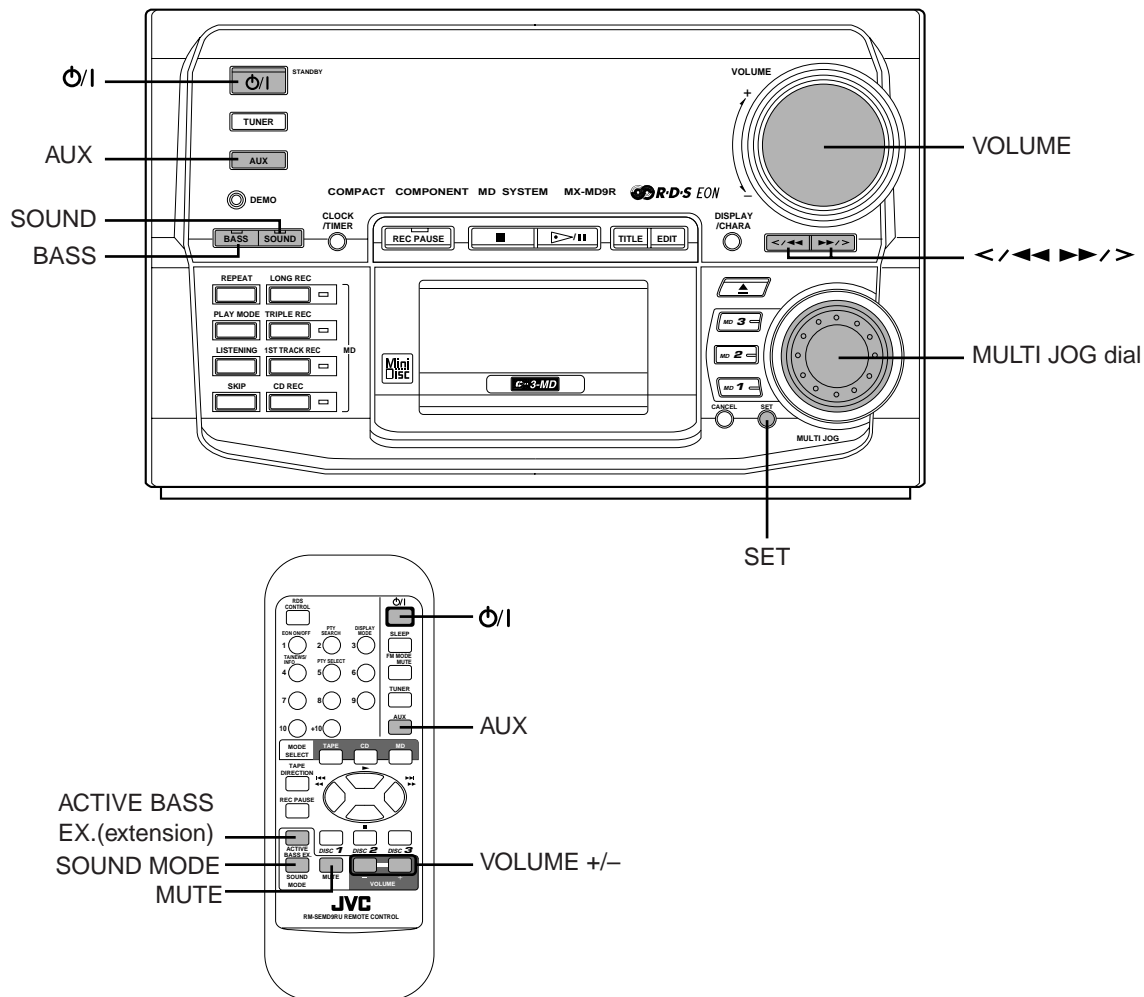

Turning the Power On and Off

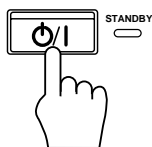

Turning the CA-MD9R On

Press the button.

“HELLO” appears on the display and the STANDBY indicator goes off.

The CA-MD9R comes on ready to play the source it was for when the power was last turned off.

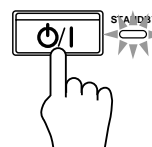

Turning the CA-MD9R Off (Standby)

Press the button again.

The STANDBY indicator lights up, “GOOD BYE” appears on the display for a while.

The clock time appears when the unit is in the standby mode.

- Some power (15 watts) is always consumed even though the unit is in standby mode.
- To switch off the unit completely, unplug the AC power cord from the AC outlet. When you unplug the AC power cord, the clock will be reset to 0:00 immediately, and preset stations will be erased in a few days.

Adjusting the Volume

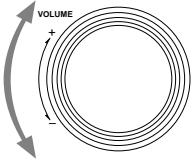

Turn the VOLUME control clockwise to increase the volume or counterclockwise to decrease it. When using the Remote Control, press the VOLUME + button to increase the volume or press the VOLUME – button to decrease it.

You can adjust the volume level between 0 (minimum) and 50 (maximum).

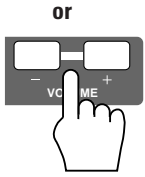

For private listening

Connect a pair of headphones to the PHONES jack. No sound comes out of the speakers. Be sure to turn down the volume before connecting or putting on headphones.

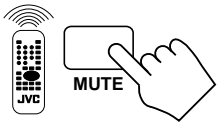

MUTING Function

Press the MUTE button on the Remote Control to turn down the volume level to 0.

To restore the volume level to its previous level, press this button again.

Reinforcing the Bass Sound

With the Active Bass Extension, you can maintain the richness and fullness of the bass sound regardless of how low you set the volume.

You can use this function only for playback.

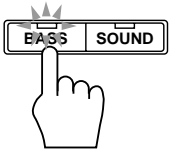

To use this function, press the BASS button on the unit or the ACTIVE BASS EX. (Active Bass Extension) button on the Remote Control. “ACT-BASS” appears on the display and the indicator on the BASS button lights up.



To cancel this function, press the button again. “OFF” appears on the display and the indicator on the BASS button goes off.

Sound Modes

The CA-MD9R has some preset sound effects that give you control of the way your music sounds, so you can tailor it for your room and for the quality of the source. You can also create your own customized S.E.A. (Sound Effect Amplifier) settings and store it in the unit's memory.

You cannot use the Sound Modes for recording.

Live surround modes

- D.(Dance) CLUB** Increases resonance and bass.
- HALL** Adds depth and brilliance to the sound, like in a concert hall.
- STADIUM** Adds clarity and spreads the sound, like in an outdoor stadium.

S.E.A. effect modes

- ROCK** Boosts low and high frequencies.
- POP** Good for vocal music.
- CLASSIC** Best for classical music.

Selecting a Sound Mode

1. Press the **SOUND** button on the unit or **SOUND MODE** button on the Remote Control repeatedly until the Sound Mode you want appears on the display.

Each time you press the button, the Sound Modes change as follow:

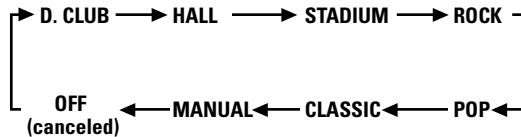
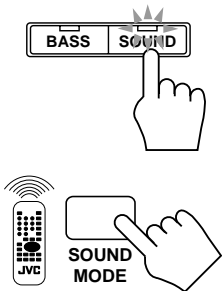

When a Sound Mode is selected, the indicator on the **SOUND** button lights up.

To cancel the Sound Mode, press the **SOUND** or **SOUND MODE** button repeatedly until “OFF” appears on the display.

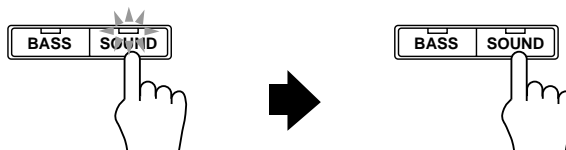

Creating Your Own Customized Sound Mode

You can create your own customized Sound Mode and store it in the CA-MD9R's memory. To do the following procedure, use the buttons on the unit.

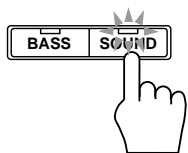

1. Press the **SOUND** button repeatedly until "MANUAL" appears on the display.

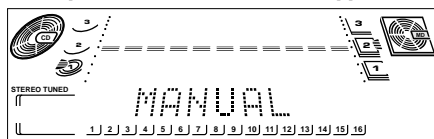

2. Press the **SET** button while "MANUAL" is shown on the display.

3. Press the **</<< or >>>/>** button to select the frequency range you want to adjust, while the adjustable frequency range (**LOW, MID, HIGH**) is shown on the display.

- You can adjust 3 different frequency ranges:

LOW: for the low frequency range
MID: for the middle frequency range
HIGH: for the high frequency range

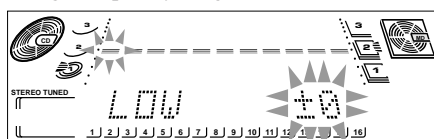
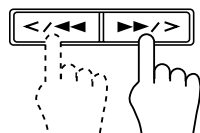

4. Rotate the **MULTI JOG** dial to adjust the level of the selected range.

- The level can be adjusted between +3 and -3 in seven steps.

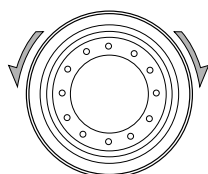

MULTI JOG

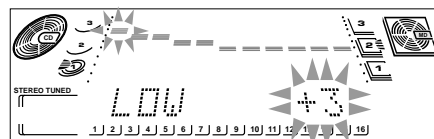

5. Press the **SET** button again to memorize your settings.

To select your own customized Sound Mode, press the **SOUND** button repeatedly (or the **SOUND MODE** button on the Remote Control) so that "MANUAL" appears on the display.

Using an External Component

Listening to an External Component

By playing the sound from an external component through the CA-MD9R, you can gain control over how the music sounds. Once the connected component is playing through the CA-MD9R, you can apply the sound effects.

- First make sure that the external component is properly connected to the CA-MD9R. (See page 5.)

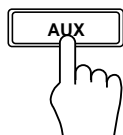

1. Press the **AUX** button on the unit or on the Remote Control.

"AUX" appears on the display.

2. Start playing on the external component.

- To operate the external component, refer to the manual supplied with it.

3. Adjust the **VOLUME** control and select a Sound Mode if you want.

To cancel the setting

Change the source by starting any one of the CA-MD9R's built-in sound sources, such as the **CD Player** or **MD Recorder**.

Using the Tuner

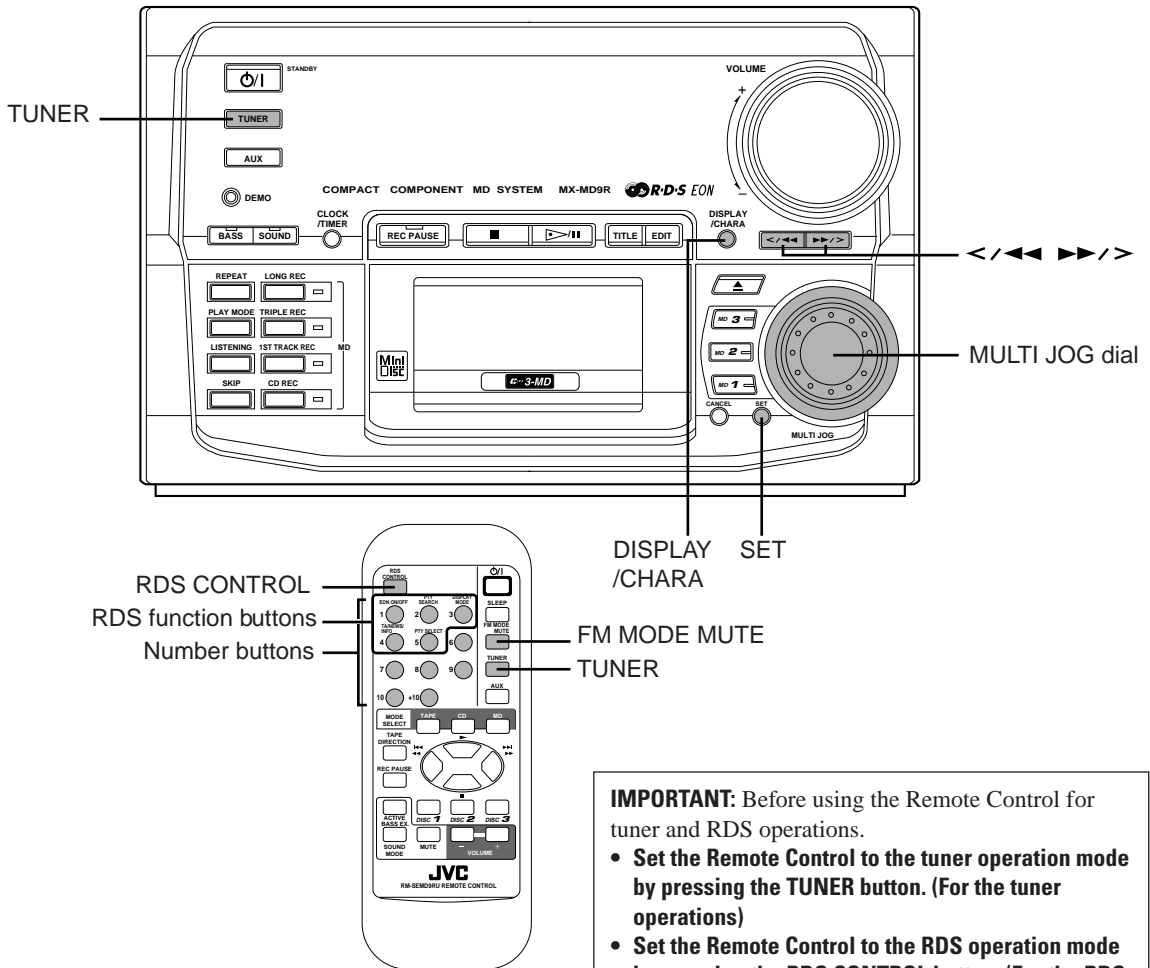

IMPORTANT: Before using the Remote Control for tuner and RDS operations.

- Set the Remote Control to the tuner operation mode by pressing the TUNER button. (For the tuner operations)
- Set the Remote Control to the RDS operation mode by pressing the RDS CONTROL button. (For the RDS operations)

You can listen to both FM and AM (MW/LW) stations. Stations can be tuned in manually, automatically, or from preset memory storage.

Before listening to the radio:

- Check that both the FM and AM (MW/LW) antennas are firmly connected. (See page 4.)

One Touch Radio

Just press the TUNER button to turn on the unit and start playing the most recent station tuned in.

You can switch from any other sound source to the radio by pressing the TUNER button.

Tuning in a Station

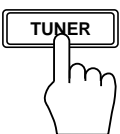

Press the TUNER button to turn on the radio.

The frequency of the previously selected station appears on the display.

Switching between Frequency Bands

Press the TUNER button on the unit.

Each time you press the button, the band alternates between FM and AM (MW/LW).

If you press the TUNER button on the Remote Control, the band will not alternate.

Selecting a Radio Station

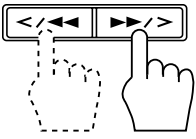

- Press the </<< or >>/> button on the unit repeatedly. The frequency changes in one step increments. "TUNED" appears on the display when a station is tuned in.
- Press and hold the </<< or >>/> button for a few seconds, the frequency changes continuously until a station is tuned in. "TUNED" appears on the display.

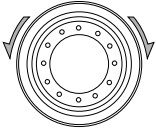

- Possible only after presetting stations (For presetting methods, see "Presetting Stations" below).
- Using the unit**
Select a preset channel by rotating the MULTI JOG dial clockwise or counterclockwise.

Using the Remote Control

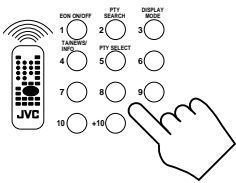

1. Press the TUNER button so that you can receive the most recent station tuned in.
2. Press the number button for the preset station you want.
 - Example: For channel 5, press 5. For channel 15, press +10 then 5. For channel 20, press +10, then 10. For channel 30, press +10 two times, then 10.

Presetting Stations

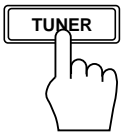

You can store up to 30 stations (FM and AM (MW/LW)). To do the following procedure, use the buttons on the unit.

Note: In some cases, test frequencies have been already memorized for the tuner since the factory examined the tuner preset function before shipment. This is not a malfunction. You can preset the stations you want into memory by following the presetting method.

1. Tune to a station you want to preset (see "Tuning in a Station" on page 11).
2. Press the SET button.

On the display, "--" (preset number position) will flash for 5 seconds.

- During these 5 seconds while the indication on the display is flashing, you can assign a channel number to the station and enter it into the memory.

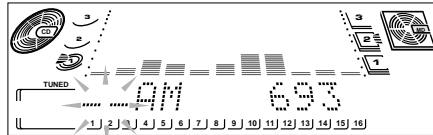

3. Rotate the MULTI JOG dial clockwise or counterclockwise to select a preset number.
4. Press the SET button again.

"MEMORY" appears on the display and the selected station will be preset in the channel number you have specified.

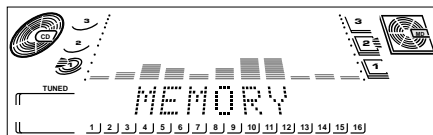

- If a station has been previously stored in the same channel number, it will be erased and the newly selected station will be stored.

5. Repeat steps 1 to 4 for each station you want to store in memory using different preset numbers.

CAUTION: If the unit is unplugged or if a power failure occurs, the preset stations will be erased in a few days. If this happens, preset the station again.

Changing the FM Reception Mode

When an FM stereo broadcast is hard to receive or noisy, press the FM MODE MUTE button on the Remote Control (after pressing the TUNER button on the Remote Control) so that “MONO” appears on the display. (The STEREO indicator goes off.) Reception improves, but there are no stereo effects.

In this monaural mode, noise comes out while tuning in stations (since muting is canceled).



To restore the stereo effect, press the FM MODE MUTE button again so that “AUTO” appears on the display.

In this stereo mode, no noise comes out while tuning in stations, and you can hear stereo sounds when a program is broadcast in stereo (the STEREO indicator lights up).

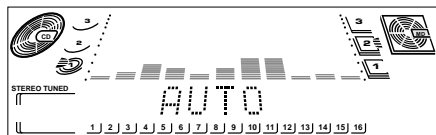

Receiving FM Stations with RDS



RDS (Radio Data System) allows the FM stations to send additional signals along with their regular program signals. For example, the stations send their station names and information about what type of program they broadcast, such as sports or music, etc.

When tuned to an FM station providing the RDS signals, the RDS indicator lights up and the station name, if sent, is displayed.

One convenient RDS service is “Enhanced Other Networks (EON)” (see page 16). This allows the unit to automatically switch to a program type of your choice when one starts in your local area.

- Not all FM stations provide RDS service, nor do all RDS stations provide the same services. If in doubt, check with local radio stations for details on RDS services in your area.
- RDS may not work correctly if the station you are tuned in is not transmitting the signals properly or if the signal strength is weak.

What Information RDS Can Provide

The CA-MD9R can use the following RDS service.

PS (Program Service name)

Identifies each station by a name.

RT (Radio Text)

Allows the RDS station to send text messages that appear on the display.

PTY (Program Type) (see next page for a description of the PTY codes)

Identifies the type of RDS program. This allows you to locate a specific type of program being broadcast.

EON (Enhanced Other Networks)

Provides the information about the program types sent by the other RDS stations than the one being received.

Description of the PTY codes:

NONE:	Undefined.
NEWS:	News.
AFFAIRS:	Topical program expanding or enlarging upon the news — debate, or analysis.
INFO:	Program the purpose of which is to impart advice in the widest sense.
SPORT:	Program concerned with any aspect of sports.
EDUCATE:	Educational programs.
DRAMA:	All radio plays and serials.
CULTURE:	Programs concerning any aspect of national or regional culture, including language, theatre, etc.
SCIENCE:	Programs about the natural sciences and technology.
VARIED:	Used for mainly speech-based programs like quizzes, panel games and personality interviews.
POP M:	Commercial music of current popular appeal.
ROCK M:	Rock music.
M.O.R. M:	Current contemporary music considered to be “easy-listening.”
LIGHT M:	Instrumental music, and vocal or choral works.
CLASSICS:	Performances of major orchestral works, symphonies, chamber music, etc.
OTHER M:	Music not fitting into any of the other categories.
WEATHER:	Weather reports and forecasts.
FINANCE:	Stock Market reports, commerce, trading etc.
CHILDREN:	Programs targeted at a young audience.
SOCIAL A:	Programs about sociology, history, geography, psychology and society.
RELIGION:	Religious programs.
PHONE IN:	Involving members of the public expressing their views either by phone or at a public forum.
TRAVEL:	Travel information.
LEISURE:	Programs about recreational activities.
JAZZ:	Jazz music.
COUNTRY:	Songs which originate from, or continue the musical tradition of the American Southern States.
NATIONAL:	Current popular music of the nation or region in that country’s language.
OLDIES:	Music from the so-called “golden age” of popular music.
FOLK M:	Music which has its roots in the musical culture of a particular nation.
DOCUMENT:	Program concerning factual matters, presented in an investigative style.
TEST:	Broadcast when testing emergency broadcast equipment or receivers.
ALARM!:	Emergency announcement.

Note:

Classification of the PTY codes for some FM stations may be different from the above list.

Changing the RDS Information

You can see RDS information on the display while listening to an FM station.

To view RDS information on the display, press the DISPLAY MODE button after pressing the RDS CONTROL button on the Remote Control. Each time you press the button the display changes to show the following information:

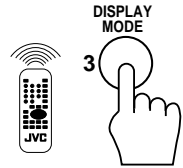

PS (Program Service):	Station names will be displayed. “no PS” appears if no signal is sent.
PTY (Program Type):	Types of broadcast programs will be displayed. “no PTY” appears if no signal is sent.
RT (Radio Text):	Text message sent by stations will be displayed. “no RT” appears if no signal is sent.
Station Frequency:	Station frequencies. (non-RDS information)

- ❑ While RDS information is being received from a station, “wait PS”, “wait PTY”, or “wait RT” may appear on the display.

Searching for Programs by PTY Codes (PTY Search)

One of the advantages of the RDS service is that you can locate a particular kind of program by specifying the PTY codes.

- ❑ The PTY Search function is applicable to preset stations only.
- ❑ PTY Search can be used even while AM (MW/LW) broadcasts are being received.



To search for a program using the PTY codes, follow this procedure, using the Remote Control:

1. Press the RDS CONTROL button.

The number buttons on the Remote Control are set for the RDS operations.

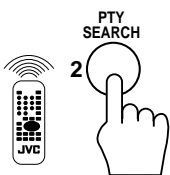

2. Press the PTY SEARCH button.

“PTY SELECT” flashes on the display.

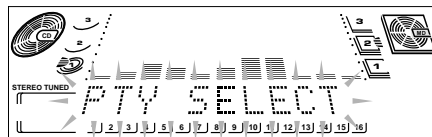

3. Press the PTY SELECT button to select a PTY code while “PTY SELECT” is flashing on the display.

Each time you press the button, the PTY codes change as follows (refer also to the list on page 14):

NONE → NEWS → AFFAIRS → INFO → SPORT → EDUCATE → DRAMA → CULTURE → SCIENCE → VARIED → POP M → ROCK M → M.O.R. M → LIGHT M → CLASSICS → OTHER M → WEATHER → FINANCE → CHILDREN → SOCIAL A → RELIGION → PHONE IN → TRAVEL → LEISURE → JAZZ → COUNTRY → NATIONAL → OLDIES → FOLK M → DOCUMENT → TEST → ALARM! → (back to the beginning)



4. Press the PTY SEARCH button again.

While searching, “SEARCH” and the selected PTY code alternate on the display.

The unit searches 30 preset channels, stops when it finds the one you have selected, and tunes in that station.



To continue searching after the first stop:

Press the PTY SEARCH button again while the indications on the display are flashing.

If no program is found, “NOT FOUND” appears on the display and the unit returns to the last received station.

To stop searching any time during the process:

Press the PTY SEARCH button while searching.

EON Function

The EON function allows the unit to switch temporarily to a broadcast program of your choice (NEWS, TA, and/or INFO) from a different station except when you are listening to a non-RDS stations (all AM (MW/LW) and some FM stations).

- The EON indicator lights up while receiving a station with the EON code.
- EON Standby reception is applicable for preset stations only.



To set EON Standby reception, use the Remote Control:

1. Press the RDS CONTROL button.

The number buttons on the Remote Control are set for the RDS operations.

2. Press the EON ON/OFF button.

The last EON data type selected — TA/NEWS/INFO — lights up.

3. Press the TA/NEWS/INFO button repeatedly until the EON data type you want is selected.

TA: Identifies that a traffic announcement is being broadcast in your area.

NEWS: News

INFO: Program the purpose of which is to impart advice in the widest sense.

Each time you press the TA/NEWS/INFO button, the EON data types change as follows:

TA	NEWS	INFO	→	TA	→	NEWS	→
				INFO	→	TA NEWS	→
TA		INFO	→	(back to the beginning)			

As soon as your selection is entered, the unit goes into EON Standby reception mode.

To cancel the EON function, press the EON ON/OFF button again so that the TA/NEWS/INFO indicator goes off.

- If you cancel the EON function while receiving a program selected by the EON function, the unit goes back to the previously tuned station.

When this unit carries out EON Standby reception, this unit functions as follows:

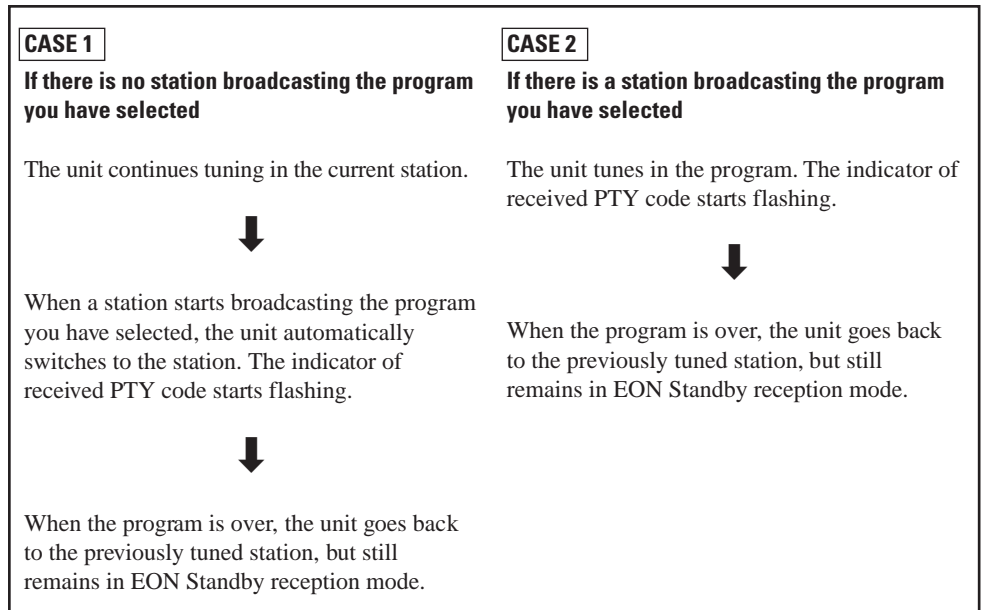

Notes:

- EON data sent from some stations may not be compatible with this unit.
- While listening to a program tuned in by the EON function, the station does not change even if another network station starts broadcasting a program of the same EON data.
- While listening to a program tuned in by the EON function, you can only use the EON ON/OFF and DISPLAY MODE button as the tuner operation buttons.
- If the stations alternate intermittently between the station tuned in by the EON function and the currently tuned station (“WAITING” flashes on the display), press the EON ON/OFF button to cancel the EON standby reception mode.

If you do not press the button, the currently tuned station is received finally, and the indication of the EON data type flashing on the display disappears.

When program of the selected EON data is completed, “EON END” appears and the unit automatically goes back to the previously tuned station.

Alarm Function

If an ALARM (Emergency) signal is received from a station while listening to the radio, the unit automatically switches to the station broadcasting the ALARM signal (“ALARM!” will flash on the display) except when you are listening to non-RDS stations (all AM (MW/LW) and some FM stations).

Test Function

The TEST signal is used for testing the ALARM function.

Therefore it makes the unit work in the same way as the ALARM signal does. If an TEST signal is received, the unit automatically switches to the station broadcasting the TEST signal (“TEST” will flash on the display).

Using the CD Player

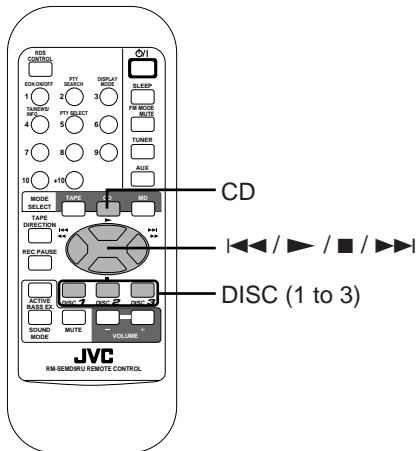
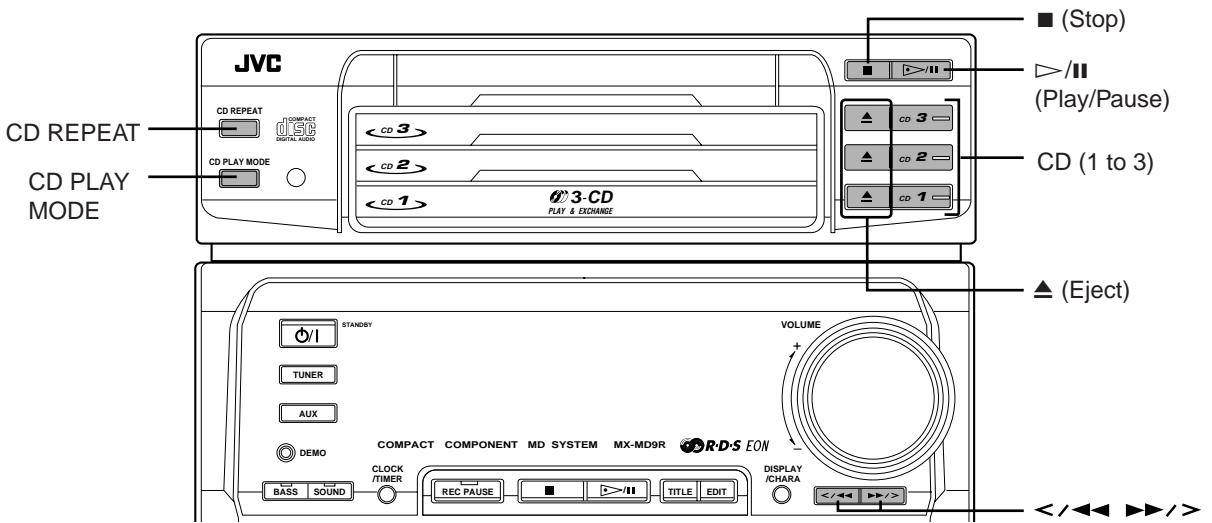

IMPORTANT: Before using the Remote Control for the CD operations, set the Remote Control to the CD operation mode by pressing the CD button.

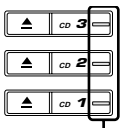

CD indicators

CD indicators on the unit

Each of the CD buttons (1 to 3) has the CD indicator. When a CD is loaded on the tray, the corresponding indicator turns on.

CD indicators on the display

Indicates that this CD is currently selected



Flashes while playing

Always lights

Lights

Lights



When an 8 cm CD is on the tray.





When a regular CD is on the tray.

When no CD is on the tray.

The Player built in the CA-MD9R has 3 CD trays. You can use Continuous, Random, Program or Repeat Play for the CDs on CD1, CD2 and CD3 trays. Repeat Play can repeat all the tracks on all the CDs, the tracks on one of the CDs or one track on one CD. There is also the Disc Lock function, prohibiting CD ejection (see page 66.)

The Quickest Way to Start a CD Is with the One Touch Operation

The power comes on, and operations are done automatically.

- Press the  button (or the  button on the Remote Control).
 - If there is a CD on the currently selected tray, playback begins from the first track of this CD.
 - If there is no CD on the currently selected tray, playback begins from the first track of the following CD.
 - If there is no CD on any of the CD trays, “CD NO DISC” appears on the display for a few seconds. Put a CD on one of the trays and press the  button (or the  button on the Remote Control)
- Press one of the CD buttons (1 to 3) (or one of the DISC buttons (1 to 3) on the Remote Control).
 - If there is a CD on the CD tray for the CD number you have selected, playback begins from the first track of that CD. If there is no CD on the CD tray, “CD NO DISC” appears on the display for a few seconds. Put a CD on that tray, then press the CD button (1 to 3) for that tray (or the corresponding DISC button (1 to 3) on the Remote Control).
- Press the  button.
 - The power comes on, and the corresponding tray comes out automatically.

Using the CD Player

Loading CDs

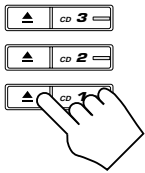

1. Press the  button on the CD Player you want to load the CD onto.

The CD tray comes out automatically.

2. Place a CD, with its label side up, onto the tray.

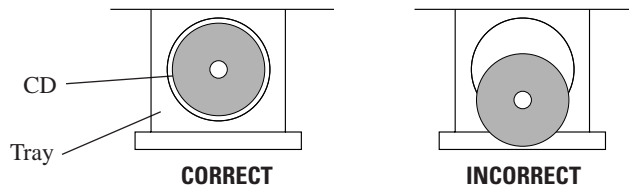

- To put an 8 cm CD on a tray, insert it so that it is aligned with the groove in the tray's center.

Note: To avoid malfunctions when you play a CD, place the CD in the right place at the center of the tray.

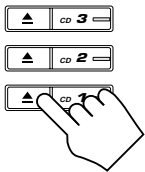

3. Press the  button to close the tray.

4. Repeat steps 1 to 3 to load other CDs on the other trays.

- To continue putting CDs on the other trays, even if a tray is open, by pressing the  button of another CD tray, the open tray will close automatically, and the new CD tray will slide out.

Playing CDs

You can play the CDs continuously. (Continuous Play)

1. Prepare the CDs.

2. Press the CD button (1 to 3) (or the DISC button (1 to 3) on the Remote Control) for the CD you want to play.

The first track of the selected CD will begin playing.

When the selected CD finishes playing, the next CD begins playing automatically.

When the last CD has finished playing, the unit stops playing the CDs.

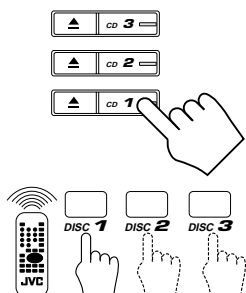

- When you press the CD button (1 to 3) (or DISC button (1 to 3) on the Remote Control) while a tray is open, the open tray will close automatically and Continuous Play playback begins from the first track of the CD.

To use Continuous Play from the first track of the currently selected CD, just press the ▷/|| button (or the ► button on the Remote Control).

Playing order of CDs

- When playback starts from CD1, the playing order is CD1 → CD2 → CD3. When CD3 has finished, the CD Player selects CD1 and stops.
- When playback starts from CD2, the playing order is CD2 → CD3 → CD1. When CD1 has finished, the CD Player selects CD2 and stops.
- When playback starts from CD3, the playing order is CD3 → CD1 → CD2. When CD2 has finished, the CD Player selects CD3 and stops.
 - If no CD is on a tray, the CD Player skips that tray.

To stop play, press the ■ button.

To remove the CD, press the ▲ button for the CD tray you want to open.

To pause, press the ▷/|| button on the unit. The indicator above the tray starts flashing.

To cancel pause, press the ▷/|| button again (or press the ► button on the Remote Control).

Changing CDs while Playing

You can replace a CD not playing, while another CD is playing.

1. Press the ▲ button for the CD not playing.

The tray comes out.

2. Replace the CD on the tray.

3. Press the ▲ button to close the tray.

Selecting a Track

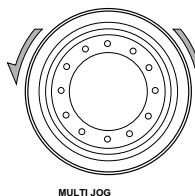

Using the unit

Rotate the MULTI JOG dial while playing or pausing.

- Rotate the MULTI JOG dial clockwise to select the next tracks.
 - Rotate the MULTI JOG dial counterclockwise to select the previous tracks.
- If you rotate the MULTI JOG dial over the last track of the selected CD, the unit jumps to the first track of the next CD.

Using the Remote Control

Press the ◀◀ or ▶▶ button while playing or pausing.

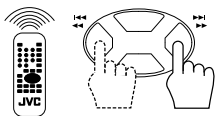

- Each time you press the ◀◀ or ▶▶ button, the track changes by one.
- Press the ▶▶ button to go ahead one track at a time.
 - Press the ◀◀ button to go back one track at a time.
- Holding down the ◀◀ or ▶▶ button allows you to change tracks continuously.

Selecting a Passage within a Track (on the unit only)

Press and hold the </> or >>/> button while playing or pausing.

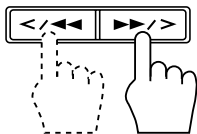

- Hold the >>/> button to fast forward the track, and release the button when you reach the passage you want to hear.
- Hold the </> button to reverse the track, and release the button when you reach the passage you want to hear.

Locating a Track with the Remote Control Directly

Using the number buttons on the Remote Control allows you to go directly to the beginning of any track.

1. Press the CD button.

The Remote Control is set to the CD operation mode.

2. Press the DISC button (1 to 3) for the CD containing the track you want to listen to.

- Example: For the third CD, press DISC 3.

3. Enter the number of the track you want to listen to with the number buttons.

The selected track starts playing.

- Example: For track 5, press 5. For track 15, press +10 then 5. For track 20, press +10, then 10. For track 32, press +10 three times, then 2.

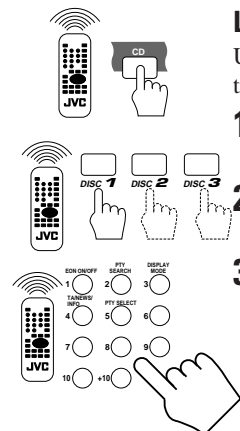

Programming the Playing Order of the Tracks

You can change the order in which the CDs and tracks play. (Program Play)

- You can program up to 32 steps in any order from among the loaded CDs.
- You can only make or change a program when the CD Player is stopped.

Using the unit

CD PLAY MODE

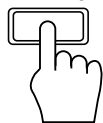

1. Press the CD PLAY MODE button repeatedly on the CD Player until the PROGRAM indicator lights up on the display.

“CD PROGRAM” also appears on the display.

- If you have already made a program, the last step of the previous program is displayed instead of “CD PROGRAM” unless you have erased the program.

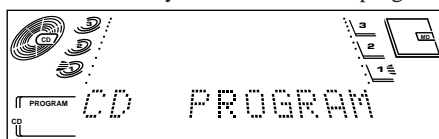

- Each time you press the CD PLAY MODE button, CD play mode changes as follows:

→ CD PROGRAM → CD RANDOM → Off (Continuous Play) → (back to the beginning)

2. Press one of the CD buttons (1 to 3) to select a CD.

The CD and track numbers start flashing.

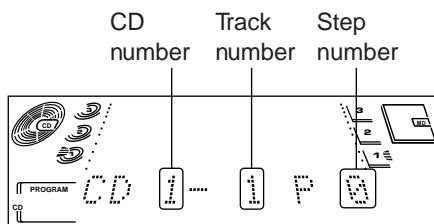
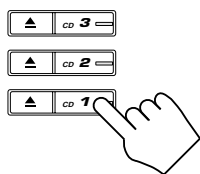

- If the CD and track numbers stop flashing, press the CD button (1 to 3) again.

3. Rotate the MULTI JOG dial to select a track.

The track number appears on the display.

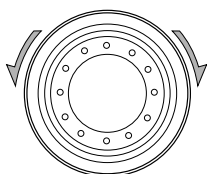

MULTI JOG

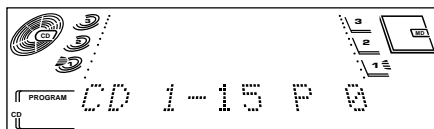

4. Press the SET button.

The CD and track numbers stop flashing, and the step number is shown.

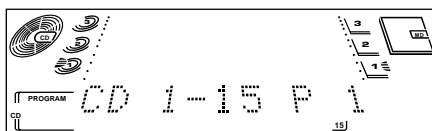

5. Repeat steps 2 to 4 to select the other tracks for the program.

- To select another track from the same CD, repeat steps 3 and 4.
- To select another track from a different CD, repeat steps 2 and 4.

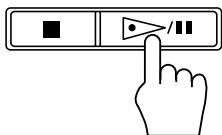

6. Press the >/II button.

The unit plays the tracks in the order you have programmed them.

Using the Remote Control

1. On the unit, press the CD PLAY MODE button repeatedly until the PROGRAM indicator lights up on the display.

“CD PROGRAM” also appears on the display.

- If you have already made a program, the last step of the previous program is displayed instead of “CD PROGRAM” unless you have erased the program.



- Each time you press the CD PLAY MODE button, CD play mode changes as follows:

→ CD PROGRAM → CD RANDOM → Off (Continuous Play) → (back to the beginning)

2. Press the CD button on the Remote Control.

The Remote Control is set to the CD operation mode.

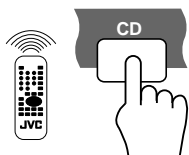

3. Press one of the DISC buttons (1 to 3).

The CD and track numbers start flashing.

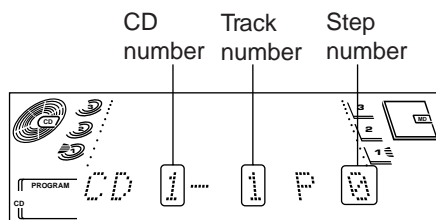
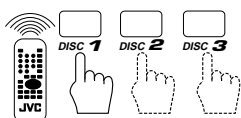

- ❑ If the CD and track numbers stop flashing, press the DISC button (1 to 3) again.

4. Press the number buttons to select the tracks.

- ❑ Example: For track 5, press 5. For track 15, press +10 then 5. For track 20, press +10 then 10. For track 32, press +10 three times, then 2.

The CD and track numbers stop flashing, and the step number is displayed.

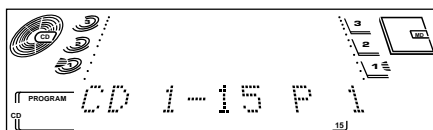
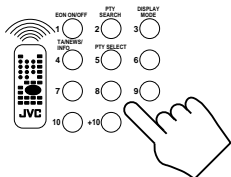

5. Repeat steps 3 and 4 to select other tracks for the program.

6. Press the ► button.

The unit plays the tracks in the order you have programmed them.

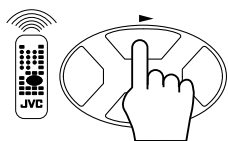

- ❑ If you try to program a 33rd step, “CD FULL” will appear on the display.
- ❑ If you try to program a track from an empty tray, or a track number that does not exist on the CD (for example, selecting track 14 on a CD that only has 12 tracks), such entries are ignored.
- ❑ You can skip to a particular program step during Program Play. Rotate the MULTI JOG dial clockwise or counterclockwise on the unit, or press the ◀◀ or ▶▶ buttons on the Remote Control.
- ❑ To play the Program Play repeatedly, press the CD REPEAT button. For details, see “Repeating a Selection or CDs” on page 24.

To stop playing, press the ■ button.

To exit Program Mode, press the CD PLAY MODE button twice to change to Continuous Play mode while the CD Player is stopped.

Checking the Program

While the CD Player is stopped, use the ◀◀ or ▶▶ buttons on the Remote Control to check the contents of the program.

Each time you press the ▶▶ button, the program contents are shown on the display in the programmed order. Pressing the ◀◀ button displays the programmed steps in the reverse order.

Changing the Program

Only possible while the CD Player is stopped.

To delete a program, press the CANCEL button on the unit. Each time you press the button, the last step is erased.

If you eject the CD, the steps programmed from that disc are also erased.

To add a track to the program, follow the procedure above (on either the unit or the Remote Control). The new tracks are added to the end of the program.

Random Play

The tracks of all loaded CDs will play at random.

CD PLAY MODE

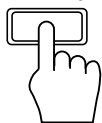

1. While the CD player is stopped, press the CD PLAY MODE button repeatedly until the **RANDOM** indicator appears on the display.

“CD RANDOM” also appears on the display.



- Each time you press the CD PLAY MODE button, CD play mode changes as follows:

→ **CD PROGRAM** → **CD RANDOM** → Off (Continuous Play) → (back to the beginning)

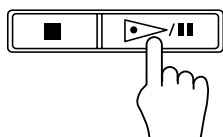

2. Press the **▷/II** button on the unit (or the **▶▶** button on the Remote Control).

The tracks of all the CDs are played at random.

When all of the tracks have been played, the CD Player stops.

- You can skip a particular track during Random Play. Rotate the MULTI JOG dial clockwise, or press the **▶▶|** button on the Remote Control.
- To play the Random Play repeatedly, press the CD REPEAT button. For details, see “Repeating a Selection or CDs” (below).

To cancel Random Play, press the **■** button, then press the CD PLAY MODE button to select another mode.

Repeating a Selection or CDs

You can have all the CDs, the program or the individual track currently playing repeat as many times as you like. (Repeat Play)

CD REPEAT



Press the CD REPEAT button on the unit.

- Each time you press the button, the Repeat Modes change as follows:

→ **REPEAT ALL** → **REPEAT 1 CD** → **REPEAT 1** → canceled → (back to the beginning)

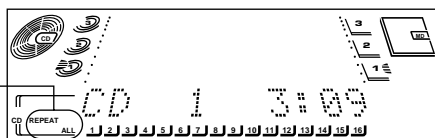

REPEAT ALL: Repeats all the tracks on the CDs, or all the tracks in the program.

REPEAT 1 CD: Repeats all the tracks on one CD.

REPEAT 1: Repeats one track on one CD.

- “REPEAT ALL” and “REPEAT 1” remain on the display even when you change the play mode.
- The three Repeat Modes above can be selected during Continuous Play, however, during Program Play and Random Play, you can only select “REPEAT ALL” or “REPEAT 1” (“REPEAT 1 CD” is not available).

To exit Repeat Mode, press the CD REPEAT button until the Repeat Mode indicator on the display goes off.

Using the MD Recorder (Playing)

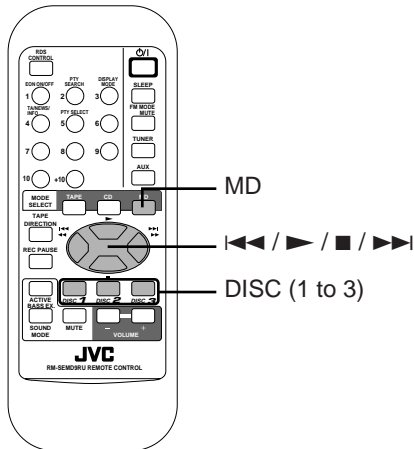
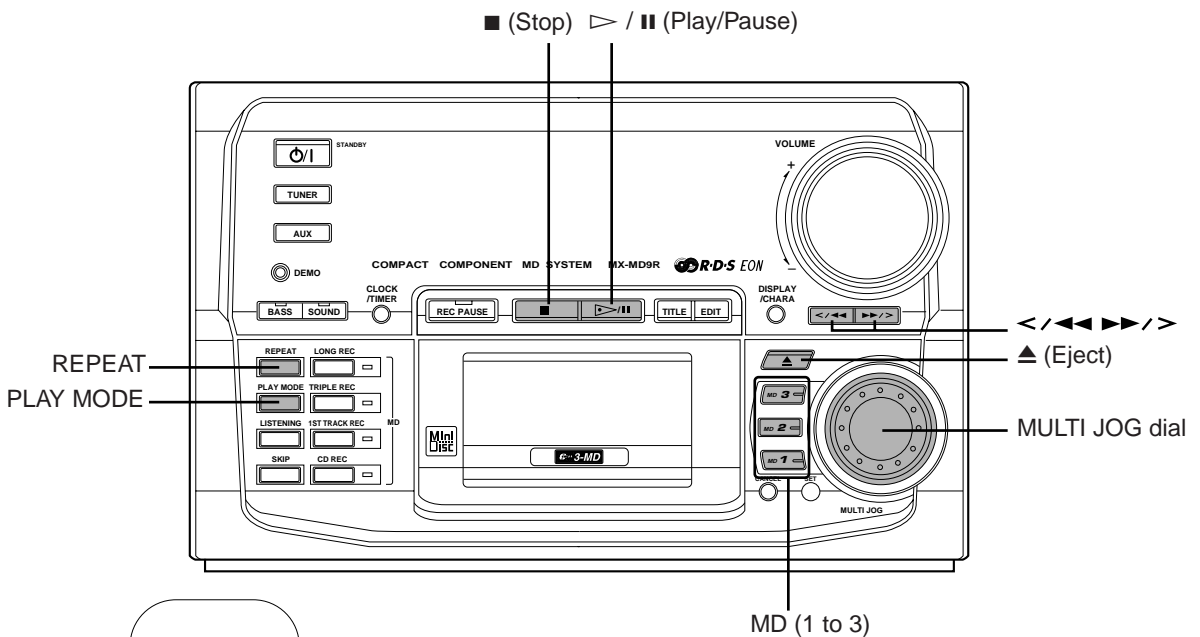

US and foreign patents licensed from Dolby Laboratories Licensing Corporation.

IMPORTANT: Before using the Remote Control for the MD operations, **set the Remote Control to the MD operation mode by pressing the MD button.**

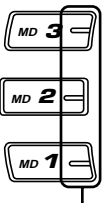

MD indicators

MD indicator on the unit

Each of the MD buttons (1 to 3) has the MD indicator. When an MD is loaded in the loading slot, the corresponding indicator turns on.

MD indicators on the display

Flashes while playing.



Always lights up

Indicates that this MD is currently selected.

Lights up



When an MD is loaded. When no MD is loaded.



The MD Recorder has 3 MD loading slots. You can use Continuous, Random, Program or Repeat Play for the MDs in MD1, MD2 and MD3 loading slots. Repeat Play can repeat all the tracks on all the MDs, the tracks on one of the MDs or one track on one MD. There is also the Disc Lock function, prohibiting MD ejection (see page 66.)

The Quickest Way to Start a MD Is with the One Touch Operation

The power comes on, and operations are done automatically.

- ❑ Press the ▷/|| button (or the ► button on the Remote Control).
 - If there is an MD in the currently selected loading slot, playback begins from the first track of this MD.
 - If there is no MD on the currently selected loading slot, playback begins from the first track of the following MD.
 - If there is no MD in any of the loading slots, “MD NO DISC” appears on the display for a few seconds. Put an MD in one of the loading slots and press the ▷/|| button (or the ► button on the Remote Control).
- ❑ Press one of the MD buttons (1 to 3) (or one of the DISC buttons (1 to 3) on the Remote Control).
 - If there is an MD in the loading slot for the MD number you have selected, playback begins from the first track of that MD. If there is no MD in the loading slot, “MD NO DISC” appears on the display for a few seconds. Put an MD in that loading slot, then press the MD button (1 to 3) for that loading slot (or the corresponding DISC button (1 to 3) on the Remote Control).
- ❑ Press the ▲ button.
 - The power comes on, and the loading slot cover opens automatically.

Using the MD Recorder

Loading MDs

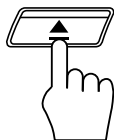

1. Press the ▲ button to the right of the MD loading slots.
The MD loading slot cover opens automatically.
2. Place up to 3 MDs, into the slots as in the illustration below.

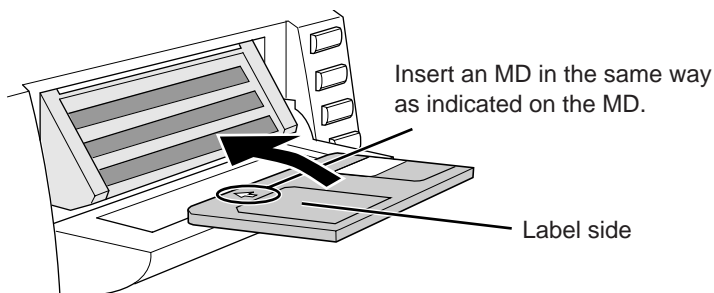

3. Press the ▲ button to close the loading slot cover.

CAUTIONS:

- **DO NOT** close the loading slot cover by hand; otherwise, the loading mechanism will be damaged.
- **DO NOT** load an MD incorrectly. Always follow the indication on the MD.

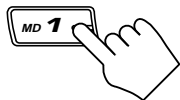

Playing MDs

You can play the MDs continuously. (Continuous Play)

1. Prepare the MDs.

2. Press the MD button (1 to 3) (or the DISC button (1 to 3) on the Remote Control) for the MD you want to play.

The first track of the selected MD will begin playing.

When the selected MD finishes playing, the next MD will begin playing automatically.

When the last MD has finished playing, the unit will stop playing the MDs.

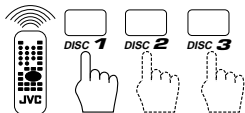

- When you press the MD button (1 to 3) (or DISC button (1 to 3) on the Remote Control) while the loading slot cover is open, the cover will close automatically and Continuous Play playback begins from the first track of the MD.

To use Continuous Play from the first track of the currently selected MD, just press the ▷/|| button (or ► button on the Remote Control).

Playing order of MDs

- When playback starts from MD1, the playing order is MD1 → MD2 → MD3. When MD3 has finished, the MD Recorder selects MD1 and stops.
- When playback starts from MD2, the playing order is MD2 → MD3 → MD1. When MD1 has finished, the MD Recorder selects MD2 and stops.
- When playback starts from MD3, the playing order is MD3 → MD1 → MD2. When MD2 has finished, the MD Recorder selects MD3 and stops.
 - If no MD is in the loading slot, the MD Recorder skips that slot.

To pause, press the ▷/|| button.

To cancel pause, press the ▷/|| button again (or press the ► button on the Remote Control).

To stop play, press the ■ button.

Changing MDs While Playing

You can replace an MD not being played, while another MD is playing.

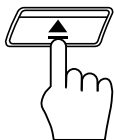

1. Press the ▲ button.

The MD loading slot cover opens.

2. Replace the MD in the loading slot.

3. Press the ▲ button to close the loading slot cover.

Note: When you open the MD loading slot cover to replace MDs, the slot of the currently playing MD appears empty. Do not put any MD in this slot. If you put an MD in this slot and close the cover, the cover automatically opens after the unit check that there has already been an MD in this slot and “OCCUPIED” appears on the display.

Selecting a Track

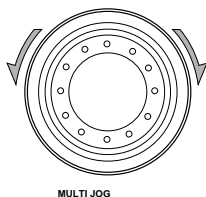

Using the unit

Rotate the MULTI JOG dial while playing or pausing.

- Rotate the MULTI JOG dial clockwise to select the next tracks.
 - Rotate the MULTI JOG dial counterclockwise to select the previous tracks.
- If you rotate the MULTI JOG dial over the last track of the selected MD, the unit jumps to the first track of the next MD.

Using the Remote Control

Press the **◀◀** or **▶▶** button while playing or pausing.

- Each time you press the **◀◀** or **▶▶** button, the track changes by one.
 - Press the **▶▶** button to go ahead one track at a time.
 - Press the **◀◀** button to go back one track at a time.
- Holding down the **◀◀** or **▶▶** button allows you to change tracks continuously.

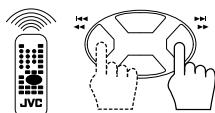

Selecting a Passage within a Track (on the unit only)

Press and hold the **</◀◀** or **▶▶/>** button while playing or pausing.

- Hold the **▶▶/>** button to fast forward the track, and release the button when you reach the passage you want to hear.
- Hold the **</◀◀** button to reverse the track, and release the button when you reach the passage you want to hear.

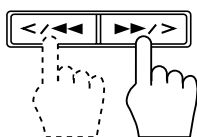

Locating a Track with the Remote Control Directly

Using the number buttons on the Remote Control allows you to go directly to the beginning of any track.

1. Press the MD button.

The Remote Control is set to the MD operation mode.

2. Press the DISC button (1 to 3) for the MD containing the track you want to listen to.

Example: For the third MD, press DISC 3.

3. Enter the number of the track you want to listen to with the number buttons.

The selected track starts playing.

Example: For track 5, press 5. For track 15, press +10 then 5. For track 20, press +10, then 10. For track 32, press +10 three times, then 2.

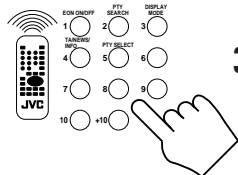
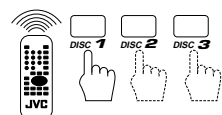
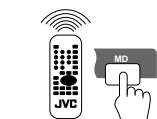

Programing the Playing Order of the Tracks

You can change the order in which the MDs and tracks play. (Program Play)

- You can program up to 32 steps in any desired order from among the loaded MDs.
- You can only make or change a program when the MD Recorder is stopped.

Using the unit

1. Press the PLAY MODE button repeatedly on the MD Recorder until the PROGRAM indicator lights up on the display.

“MD PROGRAM” also appears on the display.

- If you have already made a program, the last step of the previous program is displayed instead of “MD PROGRAM” unless you have erased the program.

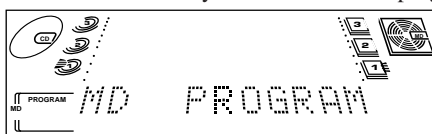

- Each time you press the PLAY MODE button, MD play mode changes as follows:

→ MD PROGRAM → MD RANDOM → Off (Continuous Play) → (back to the beginning)

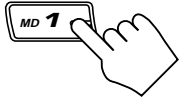

2. Press one of the MD buttons (1 to 3) to select an MD.

The MD and track numbers start flashing.

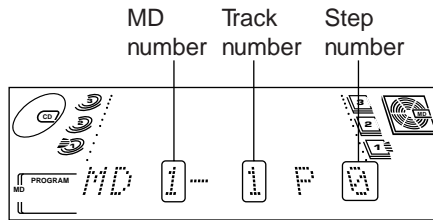

- If the MD and track numbers stop flashing, press the MD button (1 to 3) again.

3. Rotate the MULTI JOG dial to select a track.

The track number appears on the display.

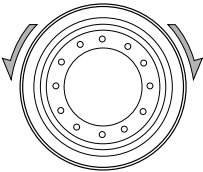

MULTI JOG

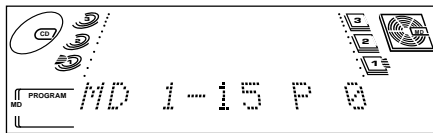

4. Press the SET button.

The MD and track numbers stop flashing, and the step number is shown.

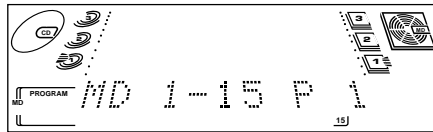

5. Repeat steps 2 to 4 to select the other tracks for the program.

- To select another track from the same MD, repeat steps 3 and 4.
- To select another track from a different MD, repeat steps 2 and 4.

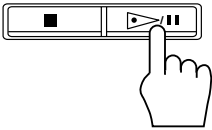

6. Press the ▷/|| button.

The unit plays the tracks in the order you have programmed them.

Using the Remote Control

PLAY MODE

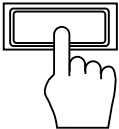

1. On the unit, press the PLAY MODE button repeatedly until the PROGRAM indicator lights up on the display.

“MD PROGRAM” also appears on the display.

- If you have already made a program, the last step of the previous program is displayed instead of “MD PROGRAM” unless you have erased the program.

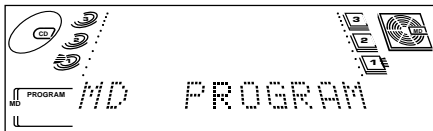

- Each time you press the PLAY MODE button, MD play mode changes as follows:

→ **MD PROGRAM** → **MD RANDOM** → Off (Continuous Play) → (back to the beginning)

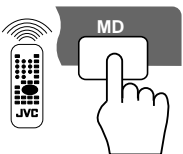

2. Press the MD button on the Remote Control.

The Remote Control is set to the MD operation mode.

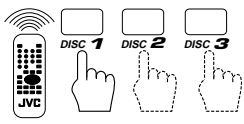

3. Press one of the DISC buttons (1 to 3).

The MD and track numbers start flashing.

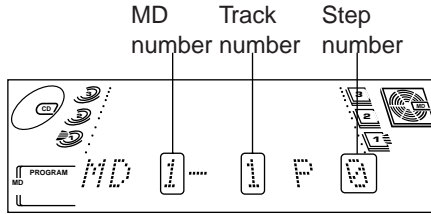

- If the MD and track numbers stop flashing, press the DISC button (1 to 3) again.

4. Press the number buttons to select the tracks.

- Example: For track 5, press 5. For track 15, press +10 then 5. For track 20, press +10 then 10. For track 32, press +10 three times, then 2.

The MD and track numbers stop flashing, and the step number is displayed.

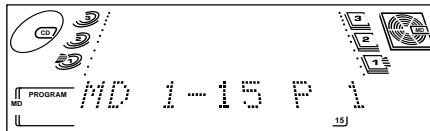

5. Repeat steps 3 and 4 to select other tracks for the program.

6. Press the ► button.

The unit plays the tracks in the order you have programmed them.

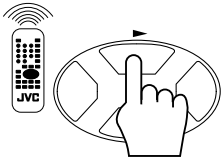

- If you try to program a 33rd step, “MD FULL” will appear on the display.
- If you try to program a track from an empty loading slot, or a track number that does not exist on the MD (for example, selecting track 14 on an MD that only has 12 tracks), such entries are ignored.
- You can skip to a particular program step during Program Play. Rotate the MULTI JOG dial clockwise or counterclockwise on the unit, or press the ◀◀ or ▶▶ buttons on the Remote Control.
- To play the Program Play repeatedly, press the REPEAT button. For details, see “Repeating a Selection or MDs” on page 31.

To stop playing, press the ■ button.

To exit Program Mode, press the PLAY MODE button twice to change to Continuous Play mode while the MD Recorder is stopped.

Checking the Program

While the MD Recorder is stopped, use the ◀◀ or ▶▶ buttons on the Remote Control to check the contents of the program.

Each time you press the ▶▶ button, the program contents are shown on the display in the programmed order. Pressing the ◀◀ button displays the programmed steps in the reverse order.

Changing the Program

Only possible while the MD recorder is stopped.

To delete a program, press the CANCEL button on the unit. Each time you press the button, the last step is erased.

If you open the loading slot cover, the program is erased.

To add a track to the program, follow the procedure above (on either the unit or the Remote Control). The new tracks are added to the end of the program.

Random Play

The tracks of all loaded MDs will play at random.

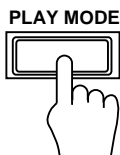

1. While the MD Recorder is stopped, press the **PLAY MODE** button repeatedly until the **RANDOM** indicator appears on the display.

"MD RANDOM" also appears on the display.



- Each time you press the **PLAY MODE** button, MD play mode changes as follows:

→ **MD PROGRAM** → **MD RANDOM** → Off (Continuous Play) → (back to the beginning)

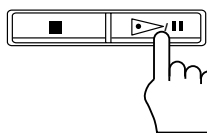

2. Press the **▷/||** button on the unit (or the **▶▶** button on the Remote Control).

The tracks of all the MDs are played at random.

When all of the tracks have been played, the MD Recorder stops.

- You can skip a particular track during Random Play. Rotate the **MULTI JOG** dial clockwise, or press the **▶▶|** button on the Remote Control.
- To play the Random Play repeatedly, press the **REPEAT** button. For details, see "Repeating a Selection or MDs" (below).

To cancel Random Play, press the **■** button, then press the **PLAY MODE** button to select another mode.

Repeating a Selection or MDs

You can have all the MDs, the program or the individual selection currently playing repeat as many times as you like. (Repeat Play)

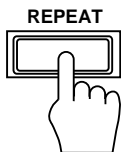

Press the REPEAT button on the unit.

- Each time you press the button, the Repeat Modes change as follows:

→ **REPEAT ALL** → **REPEAT 1 MD** → **REPEAT 1** → Canceled → (back to the beginning)

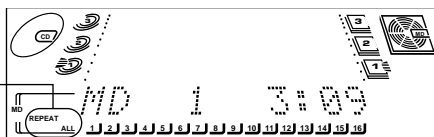

REPEAT ALL: Repeats all the tracks on the MDs, or all the tracks in the program.

REPEAT 1 MD: Repeats all the tracks on one MD.

REPEAT 1: Repeats one track on one MD.

- "REPEAT ALL" and "REPEAT 1" remain on the display even when you change the play mode.
- The three Repeat Modes above can be selected during Continuous Play, however, during Program Play and Random Play, you can only select "REPEAT ALL" or "REPEAT 1" ("REPEAT 1 MD" is not available).

To exit Repeat Mode, press the **REPEAT** button until the Repeat Mode indicator on the display goes off.

Using the MD Recorder (Recording)

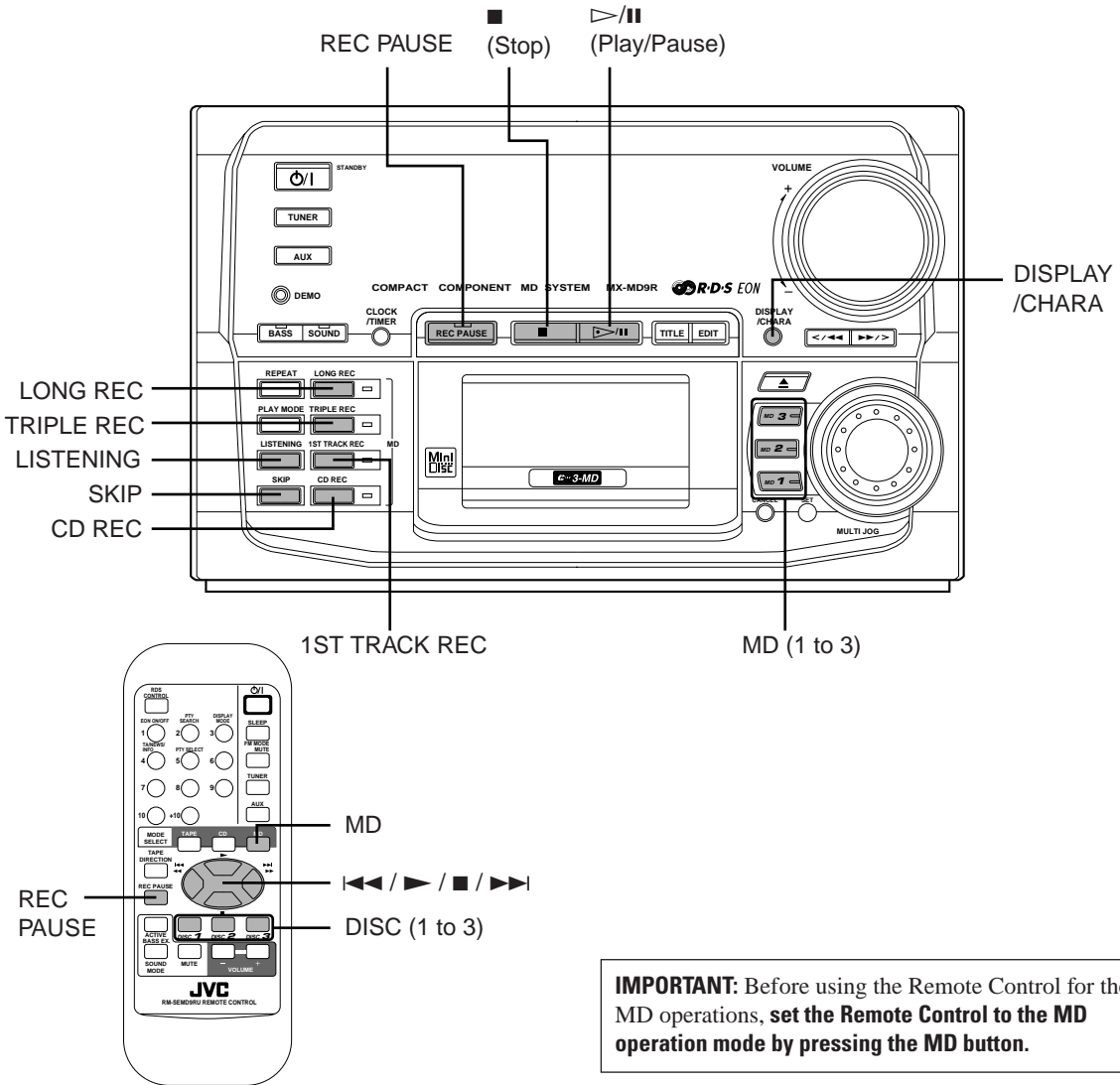

Your CA-MD9R is supplied with very powerful functions to record on the MDs. (For Editing functions, see the next chapter from page 41.)

You can do the following:

- Recording any source
 - **Standard Recording** (just record what you are listening)
 - **LONG REC:** To record a long radio program or another source continuously on 3 MDs.
- Recording CDs
 - CD REC:** To record automatically one CD on an MD by just pressing one button (One Touch Recording)

TRIPLE REC: To record automatically 3 CDs loaded on the CD trays onto 3 MDs.

LISTENING: Lets you choose which track to record from CDs onto the MD while listening.

1ST TRACK REC: Lets you automatically record the first track of each CD loaded on the CD trays.

- ❑ **It should be noted that it may be unlawful to re-record pre-recorded tapes, records, or discs without the consent of the owner of copyright in the sound or video recording, broadcast or cable programme and in any literary, dramatic, musical, or artistic embodied therein.**
- ❑ Press the DOLBY B NR button — the indicator lights up — to reduce tape hiss.
- ❑ When you record onto partially recorded MD, its contents are not erased or overwritten. The recording starts from the point following the last recorded track of the MD.
If you want to record such an MD from the beginning, you have to erase its contents first (see “ALL ERASE Function” on page 48).
- ❑ When recording a source using the Standard Recording (see page 34), you can also record the same source on a tape using the Standard Recording procedure for the Cassette Deck (see page 55).
- ❑ The recording level is automatically set correctly, so it is not affected by the VOLUME control. Thus, during recording you can adjust the sound you are actually listening to without affecting the recording level.
- ❑ When recording, you can hear Sound Modes through the speakers or headphones. However, the sound is recorded without Sound Modes (see page 9).

❑ **To avoid erasing important recordings**

Recordable MDs have an accidentally erasure prevention tab so that important recordings are not accidentally erased. When you finish recording or editing, slide open the erasure prevention tab on the cartridge side surface. New recording or editing is now no longer possible. To redo recording or editing, return the tab to the closed position.

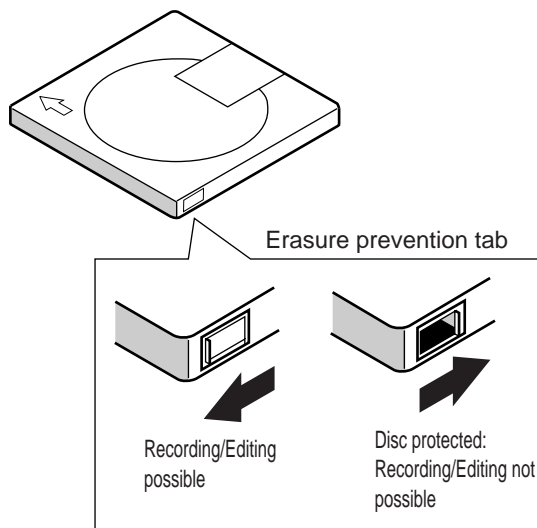

About the track marks

When playing an MD, you can move among the tracks using the </<< or >>/> button or even select directly a track using the Remote Control.

You can do that because there is a mark recorded at the front of each track enabling you to locate the track. This mark is called a “track mark” and the portion between two adjacent track marks is called a “track”.

- ❑ **When recording from a digital source** such as the CD Player, a track mark is recorded automatically at the beginning of each track.
- ❑ **When recording from an analog source** such as the radio, no track mark is recorded. This means that, when playing this MD, the MD Recorder will regard the entire recording as one track (track 1). You will not be able to select directly a song or navigate through them.
You can put track marks manually.

To put a track mark manually, during the recording, press the SET button at the place you want to put a track mark.

The MD Recorder will also consider a blank of 3 seconds or more as a blank separating 2 tracks and consequently put a track mark.

Note:

To add track mark afterwards (when the recording is over), you can use the DIVIDE function (see page 42) to divide a long recording.

To record any source currently playing use the following procedure.

- You can also record the same source on the tape at the same time. (See page 55 for tape recording.)

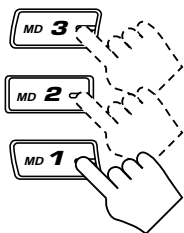

1. Insert a blank or recordable MD into one of the MD loading slots.
2. Press the MD button (1 to 3) (or the DISC button (1 to 3) on the Remote Control) corresponding to the slot number you put the MD, then press the ■ button.
3. Choose and start playing the source you want to record (CD, Tuner, Cassette Deck or the external component).



4. Press the REC PAUSE button on the MD Recorder.
The indicator on the button lights up.

5. Press the ▷ / || button to start the recording.

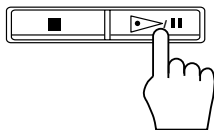

- If some tracks have been recorded on the MD, this MD Recorder searches for the end point of the previous recording, and starts recording after the end point.

To pause any time during recording process, press the ▷ / || button (or the REC PAUSE button on the Remote Control). The track mark will be recorded.

To cancel the pause, press the ▷ / || button again (or the ► on the Remote Control).

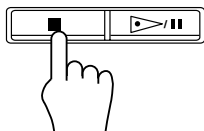

To stop recording, press the ■ button.

Changing the Display Mode

You can check the remaining time of the MD while recording.

Press and hold the DISPLAY/CHARA button on the unit. While you are holding the button, the remaining time of the MD will be shown on the display (as well as the source name you are recording).

DISPLAY
/CHARA

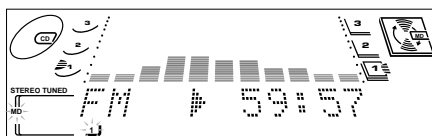

Long Recording (LONG REC)

The LONG REC function allows you to record any source continuously onto 3 MDs, enabling you to make long recording of radio program, or to record three CDs continuously, etc. The Recording begins on MD1 (MD in the MD1 slot) and continues on MD2, then MD3.

1. Insert the MDs you want to record on into the MD loading slots.

- Always use the MD1 loading slot.

If there is no MD in the MD1 slot (or if the MD is not available for recording: play only MD or full MD), the recording is automatically canceled when you press the LONG REC button in step 3.

2. Prepare the source you want to record from.

For CD recording: Put CD(s) on the CD tray(s). Since the recording begins from CD1, be sure that a CD is loaded on the CD1 tray.

You need to select the CD Player as the source by pressing the CD1 button then the ■ button.

For recording the other sources (Tuner, Cassette Deck or the external component):

Tune in the station or play the source you want to record.

3. Press the LONG REC button.

The indicator next to the LONG REC button lights up and the recording begins automatically.

If you are recording from a CD, the CD on the CD1 tray starts playing automatically.

• If you are recording from a CD:

The display changes as follows:

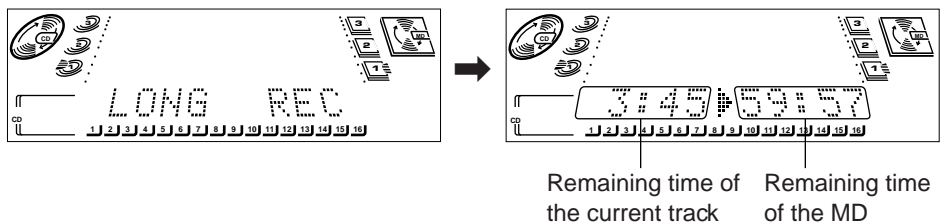

- If you are recording from another source, "LONG REC" does not appear on the display even if the unit is recording the source.

To stop recording, press the ■ button.

Note: When an MD is fully recorded, the MD Recorder automatically switches to the next MD. While switching the MDs, no recording will be made.

Changing the Display Mode

If you press and hold the DISPLAY/CHARA button on the unit while recording, the display shows the following.

• While recording CDs

CD track number currently playing

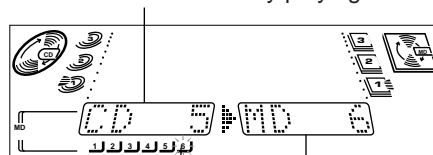

MD track number currently being recorded

• While recording the other sources

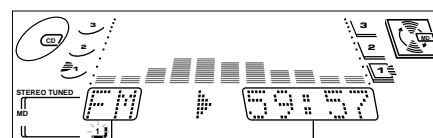

Source name

Remaining time of the MD

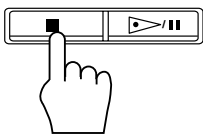
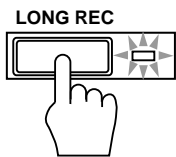

DISPLAY
/CHARA



One Touch CD Recording (CD REC)

The CD REC function allows you to easily record CDs on the MD1.

1. Prepare CDs and a recordable MD into the MD1 loading slot.

- ❑ You can load the CDs on any CD trays, but always load the recordable MD into the MD1 loading slot. If not, this function does not work.

2. Be sure that the CD you want to start recording from is selected as the playing source.

- ❑ If not, select it by pressing the corresponding CD button (1 to 3), then the ■ button.

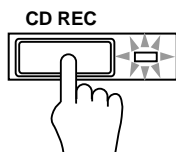

3. Press the CD REC button on the MD Recorder.

The indicator next to the CD REC button lights up and the recording begins automatically. Recording will stop when the MD in the MD1 loading slot is fully recorded.

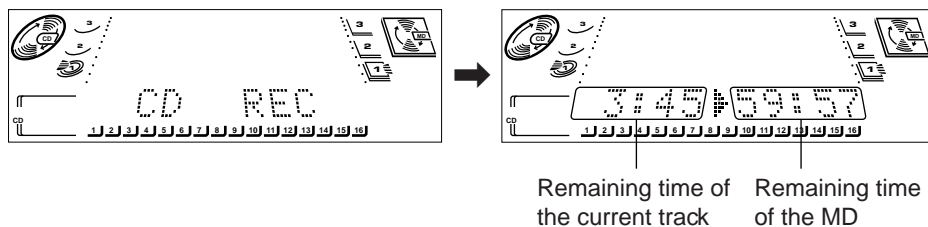

- ❑ If you press the CD REC button while playing a CD, the recording starts from the beginning of the current track, and only the current track is recorded.
- ❑ If you press the CD REC button after making a program, you can automatically record the program.

Changing the Display Mode

You can check the CD track number and the MD track number while recording.

Press and hold the DISPLAY/CHARA on the unit. While holding the button, the following information appears on the display.



CD track number currently playing

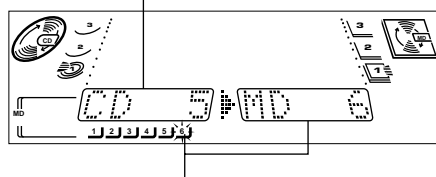

MD track number currently being recorded

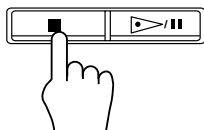

To stop recording, press the ■ button.

Three CD Recording (TRIPLE REC)

The TRIPLE REC function allows you to easily record three CDs onto three MDs.

1. Prepare CDs and recordable MDs.

- ❑ Always place a CD on the CD1 tray and insert an MD into the MD1 loading slot. If not, this function does not work.
- ❑ If you record from two CDs onto two MDs, use CD1 and 2 trays and MD1 and 2 slots.

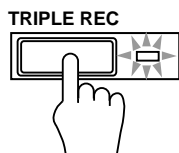

2. Press the TRIPLE REC button.

The indicator next to the TRIPLE REC button lights up and the recording begins automatically.

- ❑ The tracks of the CD1 are recorded onto the MD1, CD2 onto MD2, and CD3 onto MD3.

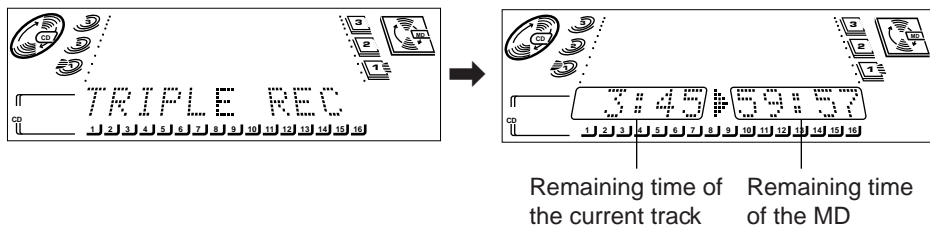

DISPLAY /CHARA



Changing the Display Mode

You can check the CD track number and the MD track number while recording.

Press and hold the DISPLAY/CHARA on the unit. While holding the button, the following information appears on the display.

CD track number currently playing

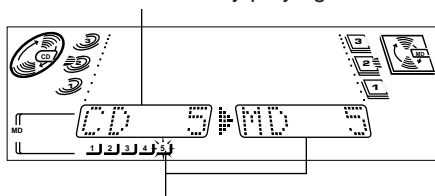

MD track number currently being recorded

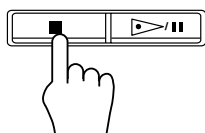

To stop recording, press the ■ button.

Listening Edit Recording (LISTENING)

The LISTENING function allows you to make a program while listening and checking each track of the loaded CDs, then to start recording the program.

- ❑ You can program up to 32 tracks.

1. Prepare CDs and a recordable MD into the MD1 loading slot.

- ❑ Always place a CD on the CD1 tray and insert the MD into the MD1 loading slot. If not, this function does not work.



2. Press the LISTENING button.

“L. EDIT” appears on the display and the unit plays the first track of the CD1.

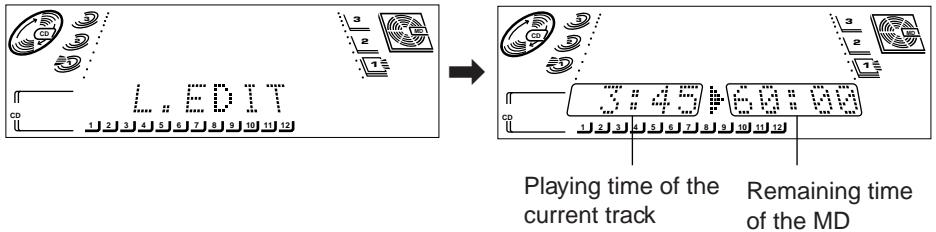

3. Decide if you want to include the current track in the program or skip it.

- **To include the current playing track in the program, press the LISTENING button again.**

The current track is programmed and the next track starts playing.



Playing time of the current track

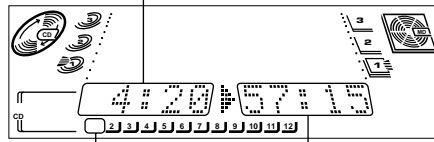

The number of the track already played disappears

Remaining time of the MD

- **To skip the current track, press the SKIP button.**

The current playing track is not programmed and the next track starts playing.

Playing time of the current track

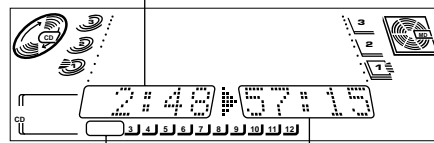
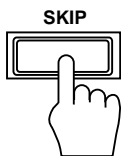

The number of the track already played disappears

Remaining time of the MD

- ❑ If you do not press the LISTENING or SKIP button, the unit will play the current track repeatedly.

4. Repeat step 3 to program other tracks.

You can check the contents of all loaded CDs.

5. When you finish checking all CDs or if there is no more remaining time for recording on the MD, recording starts automatically.

“L. EDIT” appears on the display and recording starts.

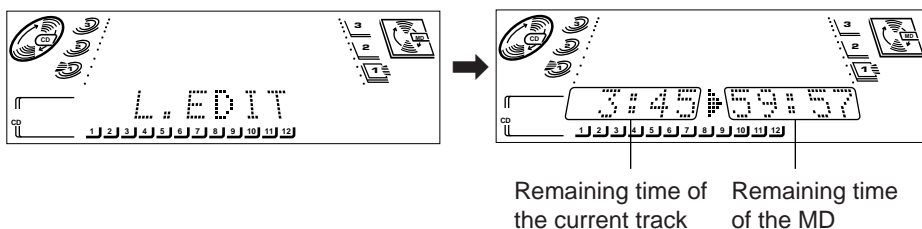

- If the remaining time of the MD becomes short, this unit will search a track fitting into the remaining time. To include the selected track in the program, press the LISTENING button. To find another track, press the SKIP button.

To finish programing and to start recording before checking all the tracks of the loaded CDs, press the CD REC button. “L.EDIT” appears and the recording starts.

To stop recording, press the ■ button.

To erase the program, press the ■ button while checking the contents of the loaded CDs.

Changing the Display Mode

You can check the CD track number and the MD track number while recording.

Press and hold the DISPLAY/CHARA button on the unit. While holding the button, the following information appears on the display.

DISPLAY
/CHARA



CD track number currently playing

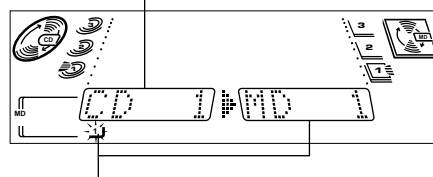

MD track number currently being recorded

First Track Recording (1ST TRACK REC)

The 1ST TRACK REC function allows you to record the first track of each loaded CD. You can, for example, make a directory of all your best CDs.

1. Prepare CDs, and a recordable MD into the MD1 loading slot.

- Always place a CD on the CD1 tray and insert the recordable MD into the MD1 loading slot. If not, this function does not work.

1ST TRACK REC

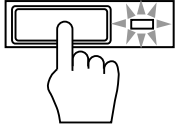

2. Press the 1ST TRACK REC button.

The indicator next to the 1ST TRACK REC button lights up and the recording starts.

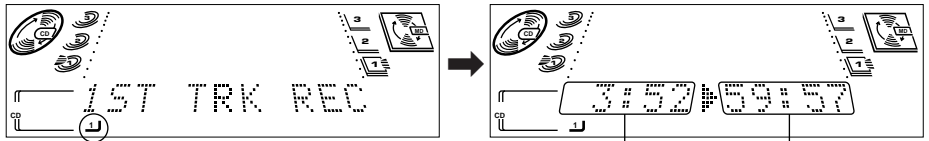

Appears only when using an 8 cm CD

Remaining time of the current track Remaining time of the MD

When the first track of the CD1 is recorded, the first track of the CD2 will be recorded. Recording continues until the first track of each loaded CD is recorded.

3. Replace the CDs on the trays not selected.

- You can change CDs to continue the First Track Recording using more than 3 CDs.

Changing the Display Mode

You can check the CD track number and MD track number while recording.

Press and hold the DISPLAY/CHARA button on the unit. While holding the button, the following information appears on the display.

DISPLAY/CHARA



CD track number currently playing

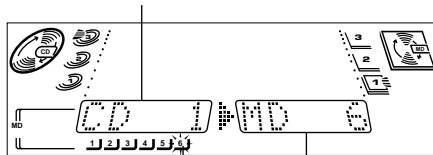

MD track number being recorded

Using the MD Recorder (Editing)

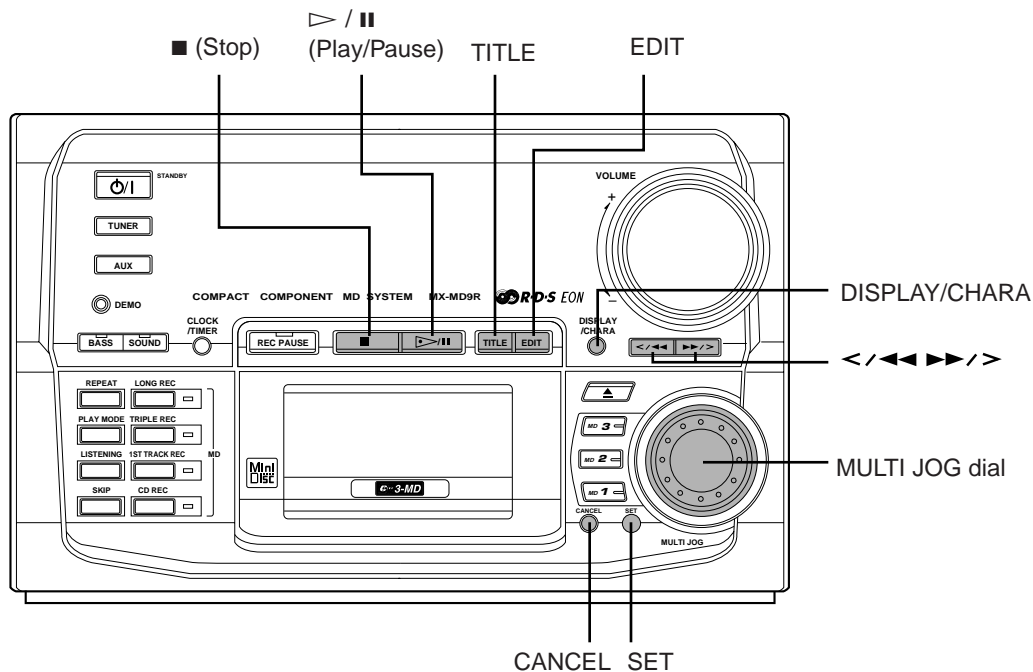

One of the great features of the MD is its capacity to be edited freely. The CA-MD9R offers you the following edit functions.

DIVIDE (see page 42):

To divide one track into two separate tracks.

JOIN (see page 44):

To join two adjacent tracks into one track.

MOVE (see page 45):

To move one track to another place (within the same disc).

ERASE (see page 47):

To erase one specific track.

ALL ERASE (see page 48):

To erase all the tracks.

Note:

By using the DIVIDE, ERASE, and JOIN functions, you can also erase an unwanted portion of a track. (see page 48)

TITLE (see page 49):

To put a name to an MD and a track.

This function allows you to divide one track into two separate tracks. It is useful, for example, when you want to add track marks at a certain point within a track or if you want to separate a recording.

1. Be sure that the MD you want to edit is in one of the MD loading slots.

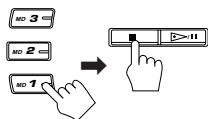

2. Select the MD you want to edit.

Press the corresponding MD button (1 to 3), then the ■ button.

3. Press the EDIT button repeatedly until "DIVIDE" appears on the display.

□ Each time you press the button, the MD editing functions change as follow:

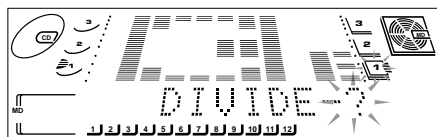
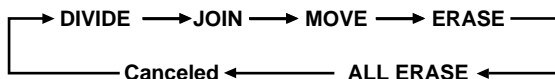
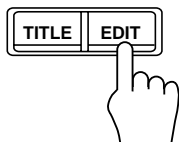

4. Press the SET button.

The playing time of the first track of the MD appears on the display.

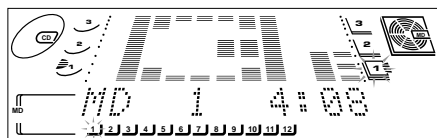

5. Rotate the MULTI JOG dial to select the track you want to divide.

Ex. When you want to divide track 3.

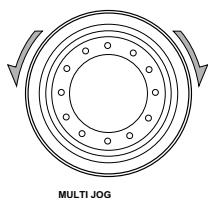

MULTI JOG

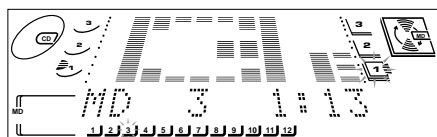

6. Press the ▷ / || button.

Playback starts.

□ If you have selected a wrong track, rotate the MULTI JOG dial to select the correct track.

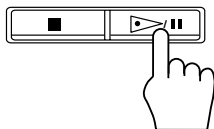

7. Press the SET button when you find the point where you want to divide the track.

The MD Recorder repeats the selected point — a portion of 3 seconds length following the dividing point.

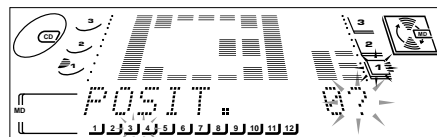

- If the dividing point is satisfactory, go to step 9.
- If the dividing point is not satisfactory, go to step 8.

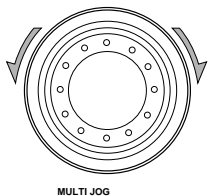

8. Rotate the MULTI JOG dial to precisely adjust the dividing point.

You can shift the dividing point up to ± 128 . This range (± 128) corresponds to approximately ± 8 seconds from the original point (Position 0).

Shifted position

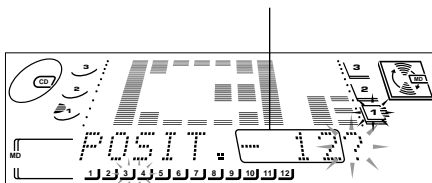

When you stop rotating the MULTI JOG dial, the unit repeats the newly selected dividing point. When you find the right position, go to step 9.

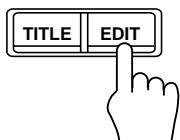

9. Press the EDIT button.



Total track number increases.

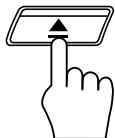

10. Press the ▲ button to eject the MD.

“WRITING” appears while the modification you have made is being recorded on the MD.

To join the divided track again, see the JOIN function on page 44.

Note: If “TRACK PROTECTED” appears on the display when you select “DIVIDE,” the track is protected and cannot be modified. To cancel this protection, see page 69.

This function allows you to join two adjacent tracks into one track.

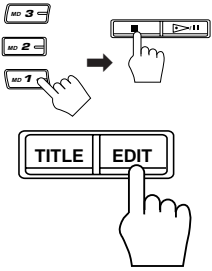

1. Be sure that the MD you want to edit is in one of the MD loading slots.
2. Select the MD you want to edit.
Press the corresponding MD button (1 to 3), then the ■ button.
3. Press the EDIT button repeatedly until "JOIN" appears on the display.
 - Each time you press the button, the MD editing functions change as follow:

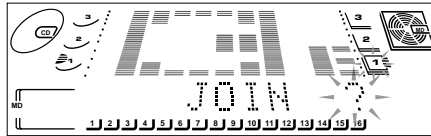
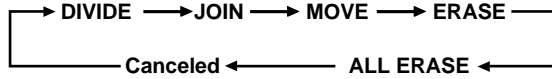

4. Press the SET button.

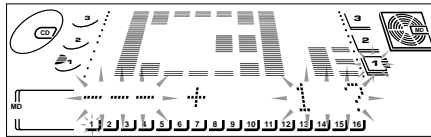

5. Rotate the MULTI JOG dial to select the two adjacent tracks you want to join.

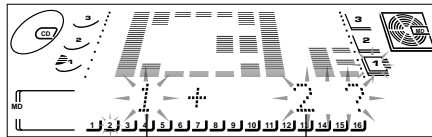
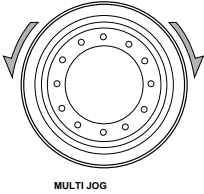

Two adjacent tracks selected

6. Press the SET button.



Two adjacent tracks selected

- If you have selected wrong tracks, press the CANCEL button then select the correct tracks by rotating the MULTI JOG dial.
- If you cancel the editing, press the ▲ button.

7. Press the EDIT button.

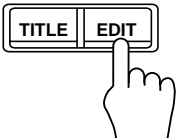

Total track number decreases.

8. Press the ▲ button to eject the MD.

"WRITING" appears while the modification you have made is being recorded on the MD.

To divide the joined tracks, see the DIVIDE function on page 42.

Note: If "TRACK PROTECTED" appears on the display when you select "JOIN," the tracks are protected and cannot be modified. To cancel this protection, see page 69.

This function allows you to move a track to the position you prefer on the same MD. It is useful to change the order of the tracks as you like.

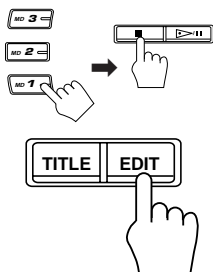

1. Be sure that the MD you want to edit is in one of the MD loading slots.

2. Select the MD you want to edit.

Press the corresponding MD button (1 to 3), then the ■ button.

3. Press the EDIT button repeatedly until "MOVE" appears on the display.

Each time you press the button, the MD editing functions change as follow:

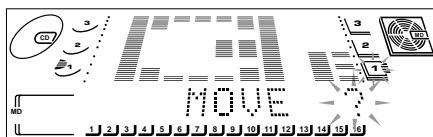
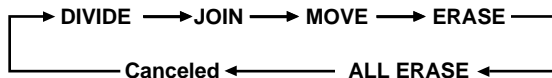

4. Press the SET button.

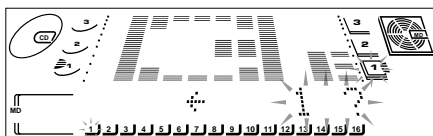

5. Rotate the MULTI JOG dial to select the track you want to move.

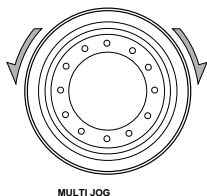

MULTI JOG

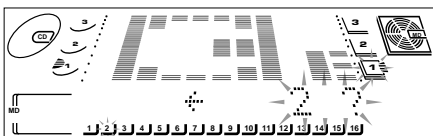

Ex. When you want to move the track 2.

6. Press the SET button.

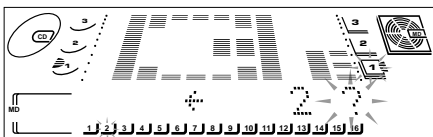

□ If you have selected a wrong track number, press the CANCEL button then select the correct track number again.

7. Rotate the MULTI JOG dial to select the position where you want to move the track.

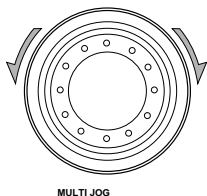

MULTI JOG

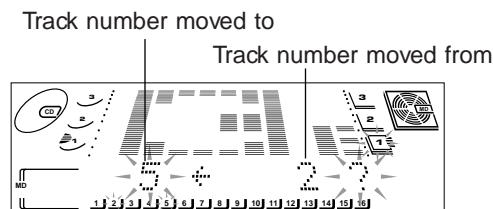

Ex. When you want to move track 2 to the track 5 position.

(Continued to the next page)



8. Press the SET button.



- If you have selected wrong track numbers, press the CANCEL button then select the correct track numbers again.
- If you cancel the editing, press the ▲ button.

9. Press the EDIT button.

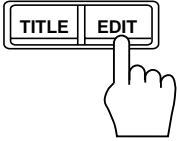

10. Press the ▲ button to eject the MD.

“WRITING” appears while the modification you have made is being recorded on the MD.

Note: If “TRACK PROTECTED” appears on the display when you select “MOVE,” the track is protected and cannot be modified. To cancel this protection, see page 69.

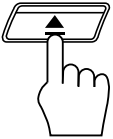

This function allows you to erase an unwanted track.

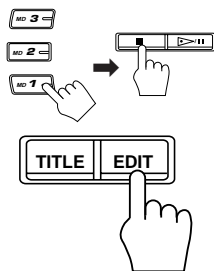

1. Be sure that the MD you want to edit is in one of the MD loading slots.
2. Select the MD you want to edit.
Press the corresponding MD button (1 to 3), then the ■ button.
3. Press the EDIT button repeatedly until "ERASE" appears on the display.
 - Each time you press the button, the MD editing functions change as follow:

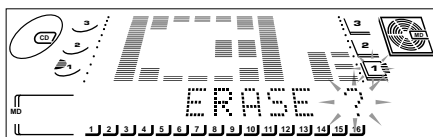
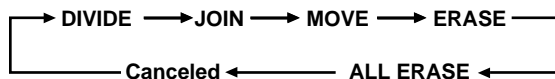

4. Press the SET button.

Track number to be erased

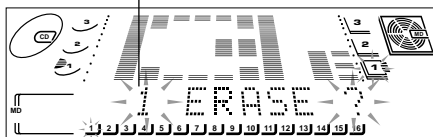

5. Rotate the MULTI JOG dial to select the track you want to erase.

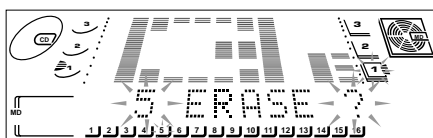
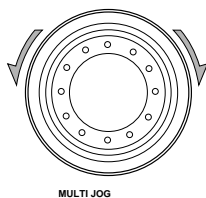

Ex. When you want to erase track 5.



6. Press the SET button.



- If you have selected a wrong track number, press the CANCEL button then select the correct track number.
- If you want to cancel the editing, press the ▲ button.

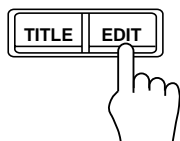

7. Press the EDIT button.



Total track number decreases.

8. Press the ▲ button to eject the MD.

"WRITING" appears while the modification you have made is being recorded on the MD.

Note: If "TRACK PROTECTED" appears on the display when you select "ERASE," the track is protected and cannot be modified. To cancel the protection, see page 69.

ALL ERASE Function

This function allows you to erase all the tracks on an MD.

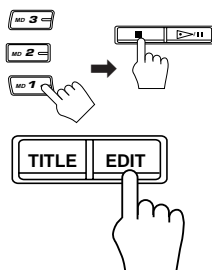

1. Be sure that the MD you want to edit is in one of the MD loading slots.
2. Select the MD you want to edit.
Press the corresponding MD button (1 to 3), then the ■ button.
3. Press the EDIT button repeatedly until "ALL ERASE" appears on the display.
 Each time you press the button, the MD editing functions change as follow:

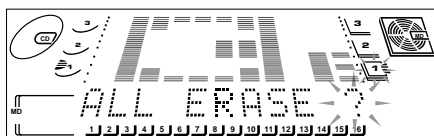
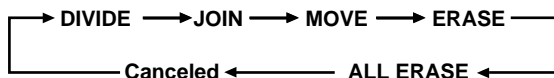

4. Press the SET button.

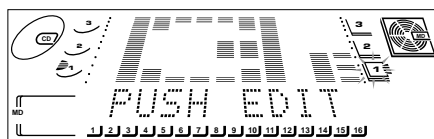

- If you want to cancel the editing, press the ▲ button.

5. Press the EDIT button.

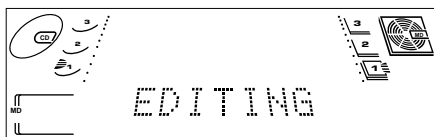
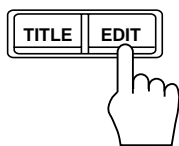

All track numbers disappear.

6. Press the ▲ button to eject the MD.

"WRITING" appears while the modification you have made is being recorded on the MD.

Note: If "TRACK PROTECTED" appears on the display when you select "ALL ERASE," the tracks are protected and cannot be modified. To cancel the protection, see page 69.

Erasing a Portion of a Track

You can erase just a portion of one track by using the DIVIDE, ERASE and JOIN functions.

1. Be sure that the MD you want to edit is in one of the MD loading slots.
2. Select the MD you want to edit.
Press the corresponding MD button (1 to 3), then the ■ button.
3. Divide a track into 3 portions to isolate the portion to erase.
Use the DIVIDE function by referring to page 42.
4. Erase the middle portion.
Use the ERASE function by referring to page 47.
5. Join the two remaining portions.
Use the JOIN function by referring to page 44.

This function allows you to give a name containing up to 32 characters to each MD and to each track.

Giving a Title to an MD

After putting a name to a disc, it will appear when you play the disc.

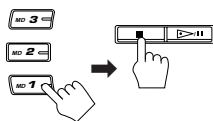

1. Be sure that the MD you want to edit is in one of the MD loading slots.

2. Select the MD you want to edit.

Press the corresponding MD button (1 to 3), then the ■ button.

3. Press the TITLE button.

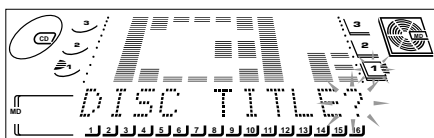

4. Press the SET button.

Cursor position flashes "A" flashes.

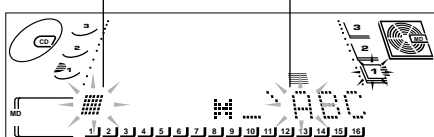

5. Press the DISPLAY/CHARA button to select the character set you want.

□ Each time you press the button, the character sets change as follows:

DISPLAY
/CHARA



Capital letters and symbols

See page 50 for more information
about these character sets.

↓
Small letters and symbols

↓
Numbers

6. Rotate the MULTI JOG dial to select a character you want.

7. Press the SET button to enter the selected character.

□ If you have entered an incorrect character, press the CANCEL button to cancel the last entry.

8. Repeat steps 5 to 7 to enter up to 32 characters.

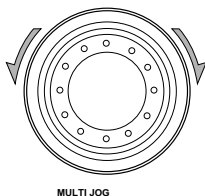

MULTI JOG



Next entry position The characters you can select.

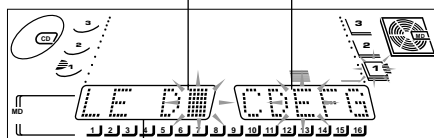

Title you are entering

□ If you want to cancel the editing, press the ▲ button.

9. Press the TITLE button to memorize the title.

"EDITING" appears on the display.

10. Press the ▲ button to eject the MD.

"WRITING" appears while the modification you have made is being recorded on the MD.

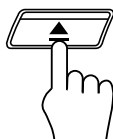

Giving a Title to a Track



1. Be sure that the MD you want to edit is in one of the MD loading slots.
2. Select the MD you want to edit.
Press the corresponding MD button (1 to 3), then the ■ button.
3. Press the TITLE button.
4. Rotate the MULTI JOG dial to select the track you want to title.

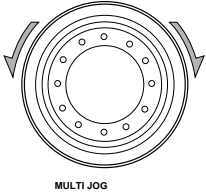

Selected track number appears.

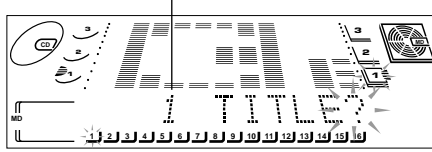

5. Follow steps 4 to 10 of page 49.

Changing the Title

You can change a title afterward:

1. Follow steps 1 to 3 of page 49 to change a MD title or steps 1 to 4 above to change a track title.
2. Press the SET button.
3. Press the </<< or >>>/> button to select the character you want to correct.
4. Repeat steps 5 to 7 of page 49.
5. Repeat steps 3 and 4 of the current procedure to correct more characters.
6. Repeat steps 9 and 10 of page 49.

To erase all the characters

Press the CANCEL repeatedly in step 3 to erase all the characters, then go to step 6.

Characters Set for Title Editing:

Capital letters set					Small letters set					Numbers set				
A	B	C	D	E	a	b	c	d	e	0	1	2	3	4
F	G	H	I	J	f	g	h	i	j	5	6	7	8	9
K	L	M	N	O	k	l	m	n	o					
P	Q	R	S	T	p	q	r	s	t					
U	V	W	X	Y	u	v	w	x	y					
Z					z									
(Blank)	!	”	#	\$	(Blank)	!	”	#	\$					
%	&	'	()	%	&	'	()					
*	+	,	-	.	*	+	,	-	.					
/	:	;	<	=	/	:	;	<	=					
>	?	@	_	\	>	?	@	_	\					

Using the Cassette Deck (Playing)

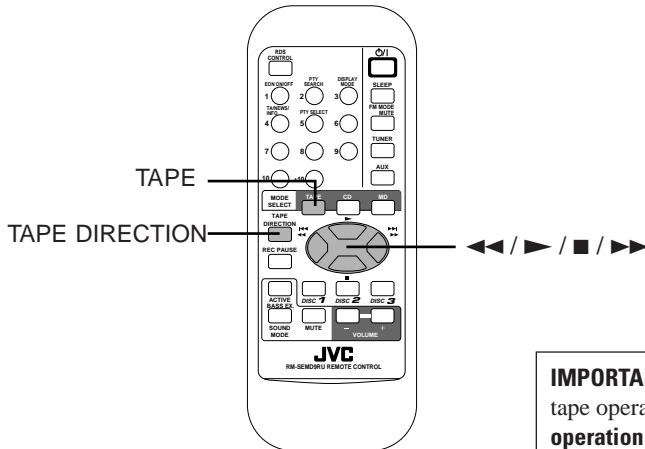
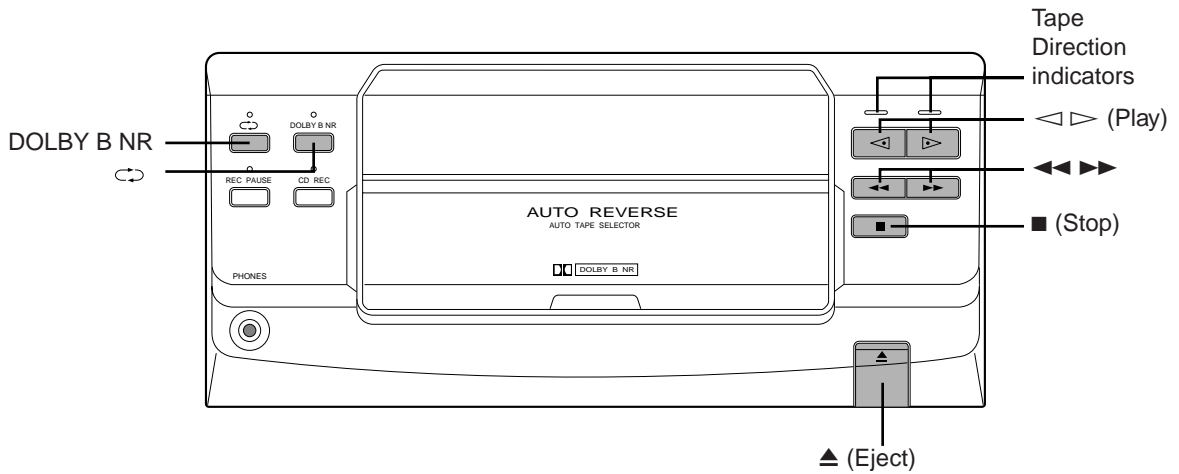

IMPORTANT: Before using the Remote Control for the tape operations, set the Remote Control to the tape operation mode by pressing the TAPE button.

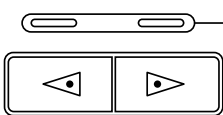

Tape Direction Indicators

Tape Direction Indicator on the unit

The Tape Direction indicator tells you which direction the tape runs. During playback, the indicator flashes slowly. During fast left or fast right, the indicator flashes quickly. During Music Scan mode, the indicator flashes slowly and quickly alternately.

- ❑ Most tapes are now recorded with the Dolby NR system, so first check which type of the Dolby NR system has been used on the tape. Only Dolby B NR is incorporated into the CA-MD9R.
- ❑ With Automatic Tape Selection, you can listen to type I, II (CrO₂) or IV (Metal) tapes without changing any settings.

The use of tapes longer than 120 minutes is not recommended, since characteristic deterioration may occur and these tapes easily jam in the pinch-rollers and the capstans.

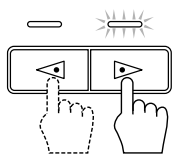

One Touch Play

- ❑ Press the ◀ or ▶ button (or the ► button on the Remote Control).
The power comes on and “TAPE” appears on the display. When a tape is already in the cassette holder, the tape is played in the direction of the button pressed. If there is no tape in the cassette holder, the CA-MD9R automatically turns on and “NO TAPE” appears on the display.

Regular Play

If the power is already on, you can use this basic procedure:

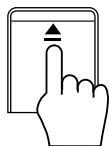

1. Press down the ▲ button.
2. When the cassette holder opens, put a cassette in, with the exposed part of the tape down, toward the base of the CA-MD9R.
 - ❑ If the cassette holder does not open, turn off the unit, then back on and press down the ▲ button again.

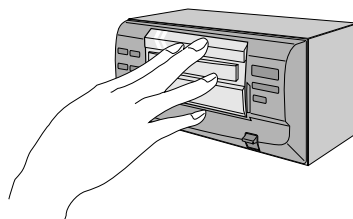
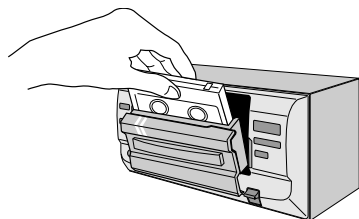

3. Close the holder gently.
4. Press the ◀ or ▶ button (or the ► button on the Remote Control).

The tape is played in the direction of the button pressed.

- ❑ The Cassette Deck automatically stops when one side of a tape has finished playing (except if the deck is in auto reverse mode: see the next page).

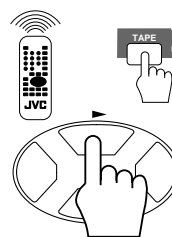
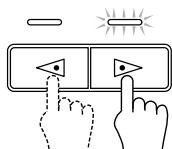

Playing the front side

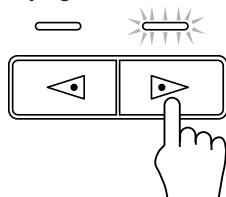

Playing the reverse side

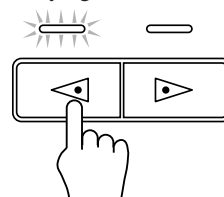

- ❑ To change the tape direction using the Remote Control, press the TAPE DIRECTION button. Each time you press the button, the tape direction alternates.

To stop playing, press the ■ button.

To remove the tape, press down the ▲ button after stopping the play.

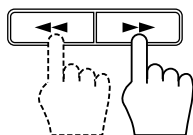

Fast Left and Fast Right

- ❑ While the tape is stopped, press the ◀◀ button and the tape will wind rapidly to the left side of the cassette without playing.
- ❑ While the tape is stopped, press the ▶▶ button and the tape will wind rapidly to the right side of the cassette without playing.

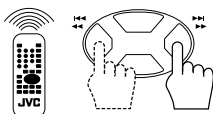

To find the beginning of a music track during play, use the Music Scan function. Music Scan searches for blank portions that usually separate selections, then plays the next selection.

Finding the Beginning of the Current Selection

Press the ◀◀ or ▶▶ button during play.

- ❑ Make sure that you press the ◀◀ or ▶▶ button in the opposite direction to that in which the tape is playing. Searching stops at the beginning of the current selection, and the current selection starts automatically.

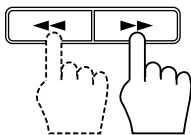

Finding the Beginning of the Next Selection

Press the ◀◀ or ▶▶ button during play.

- ❑ Make sure that you press the ◀◀ or ▶▶ button in the same direction as that in which the tape is playing. Searching stops at the beginning of the next selection, and the next selection starts automatically.

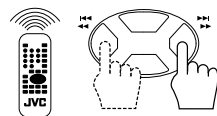

Music Scan works by detecting a 4-second long blank at the beginning of each selection, so it will not work well if your tape has...

- No blank at the beginning of a selection.
- Noise (often caused by much use or poor quality dubbing) which fills the blank.
- Long, very soft passages or pauses in a selection. The scan will detect these as 4-second long blanks. If this happens, just scan again until you reach the selection you want.

Other Useful Features of the Cassette Deck

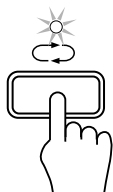

- ❑ Use the auto reverse mode to make the tape automatically reverse at the end of a side and start playing the other side. Each time you press the ↻ button, the auto reverse mode turns on (the indicator lights up) and off (the indicator goes off).

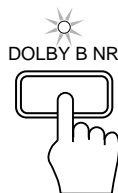

- ❑ Press the DOLBY B NR button to switch Dolby B NR* on (the indicator lights up) or off (the indicator goes off). If a tape is recorded with the Dolby B NR system, playing it back with the Dolby B NR on will reduce tape noise and improve the clarity of the sound.

*Dolby noise reduction manufactured under license from Dolby Laboratories Licensing Corporation.
“DOLBY” and the double-D symbol are trademarks of Dolby Laboratories Licensing Corporation.

Using the Cassette Deck (Recording)

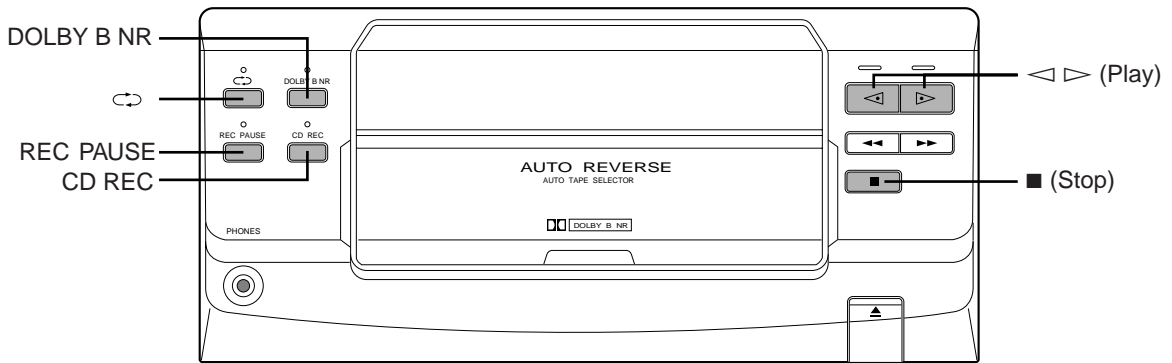

IMPORTANT: Before using the Remote Control for the tape operations, **set the Remote Control to the tape operation mode by pressing the TAPE button.**

Things to Know Before You Start Recording

- ❑ It should be noted that it may be unlawful to re-record pre-recorded tapes, records, or discs without the consent of the owner of copyright in the sound or video recording, broadcast or cable programme and in any literary, dramatic, musical, or artistic embodied therein.
- ❑ Press the DOLBY B NR button — the indicator lights up — to reduce tape hiss.
- ❑ When you want to record onto both sides of a tape, turn on the auto reverse mode. However, recording automatically stops after recording in the ◀ direction with the auto reverse mode on. Therefore, make sure that the tape direction is ▶ when recording with the auto reverse mode on.
- ❑ The recording level is automatically set correctly, so it is not affected by the VOLUME control. Thus, during recording you can adjust the sound you are actually listening to without affecting the recording level.
- ❑ Two small tabs on the cassette tape, one for side A and one for side B, can be removed to prevent accidental erasure or re-recording. To record on a cassette with the tabs removed, you must cover the holes with adhesive tape first. However, when a type II tape is used, only cover part of the hole as shown, since the other part of the hole is used to detect the tape type.
- ❑ When recording, you can hear Sound Modes through the speakers or headphones. However, the sound is recorded without Sound Modes (see page 9).
- ❑ Type I and Type II tapes can be used for recording.

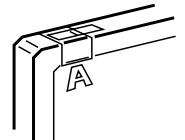

Note: The first and end portions of the tape are called leader tape, which cannot be recorded onto. When you start recording, the first part of the recording may not be done because of this leader tape. Before inserting the cassette, first wind the leader tape.

CAUTION: If recordings you have made have excessive noise or static, the unit may be too close to a TV which has been on during recording. Either turn off the TV or increase the distance between the TV and the CA-MD9R.

You can record any sound source on the tape.

- You can also record the same source on the MD at the same time. (See page 34.)

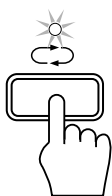



Using the unit only

1. Insert a blank or erasable tape into cassette holder.

2. Press the button if you want to record on both sides of the tape.

The indicator above the button lights up.

- When using the auto reverse mode, press the  button then the  button to start recording in the forward () direction.

3. Prepare the source, for example, by tuning in a radio station, loading CDs or MDs, or turning on the external component.

4. Press the REC PAUSE button.

The indicator above the button lights up and the CA-MD9R enters recording pause mode.

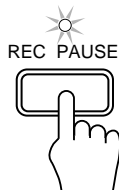

5. Press the (or) button to record the front side (or the reverse side).

- When using the auto reverse mode to record both sides of a tape, press the  button to begin the recording from the front side.

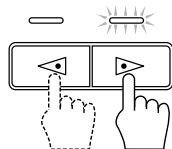

To pause, press the REC PAUSE button. Then press either the  or  button to restart recording.

To stop recording, press the  button.

To remove the tape, press down the  button after stopping the play.

If you are recording an AM (MW/LW) broadcast and you hear interference, move the BEAT CUT switch on the back panel from position 1 (the normal mode) to position 2.

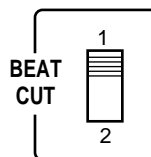





Everything on the CD goes onto the tape in the order it is on the CD, or according to the order you have set in a program. You can even record in Random Play. In this case, the tracks of the 3 CDs are recorded randomly on the tape.

1. Prepare CDs. (See page 19.)

Check that the CD Player is not playing a CD.

2. Insert a blank or erasable cassette in the cassette holder.

- When you want to record on both sides of a tape, press the  button to turn on the auto reverse mode. In this case, press the  button then the  button to start recording in the forward () direction.

3. Press the CD REC button.

“CD → TAPE” appears on the display then the unit plays the CD and starts recording.

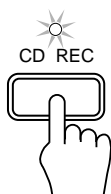

At the end of the tape, the CA-MD9R automatically goes back to the beginning of the last selection and re-records it, this time gently fading out at the end. If you have the auto reverse mode, the reverse side starts with the last selection of the front side. The last selection of the reverse side will also fade out at the end. (A 10 second blank is created at the beginning of the reverse side.)

When the recording is finished, the CD Player and Cassette Deck stop.

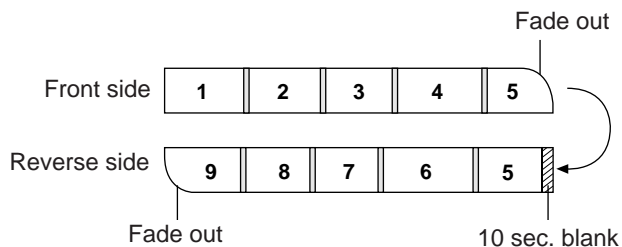

To stop recording, press the  button on the Cassette Deck or CD Player (or the  button on the Remote Control).

Notes:

- When recording from a CD program (or random play) made from more than one CD, the tape will pause when the unit switches to another CD. Then, when the CD is ready, the unit releases the pause and continue the recording.
- When making Sleep Timer setting while doing CD Direct recording, set the time so that there is enough leeway to finish the recording before the power goes off. If the time is set to about the length of the CD, the power may go off before recording finishes.
- For CD Direct Recording using more than one CD, use a blank tape. If you use a prerecorded tape, prerecorded sound may not be erased between newly-recorded tracks.

Using the Timers

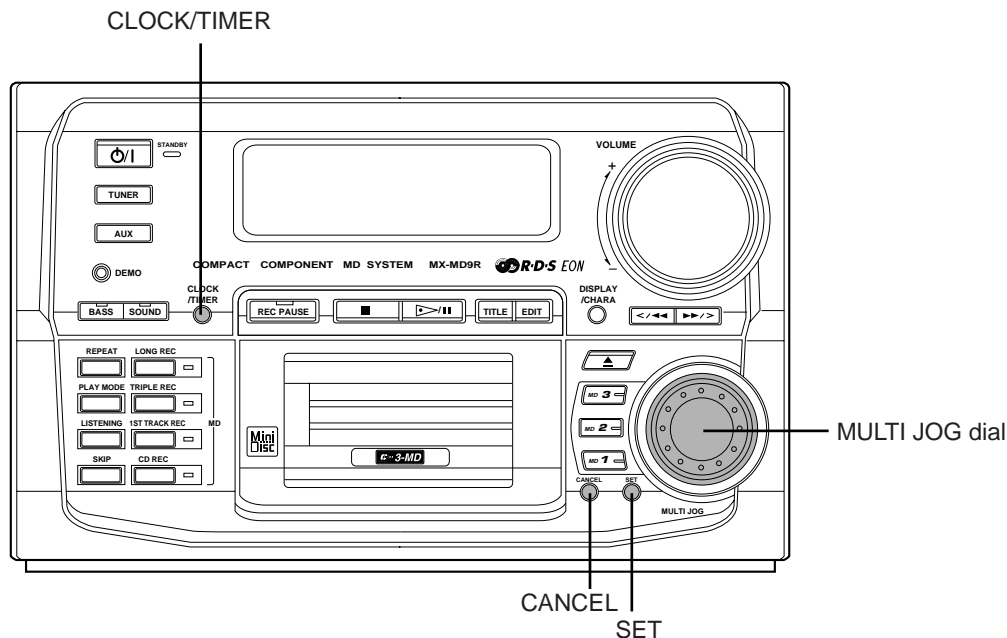

The timers let you control recording and listening functions automatically.

Three types of timers are available:

- Daily Timer** — Use this timer to set wake up everyday to music from any source.
- Recording Timer** — Unattended recording of radio broadcasts. You can set the starting time and length of the recording. You can set up to 3 Recording Timer settings.
- Sleep Timer** — Fall asleep and have your CA-MD9R turn off automatically after a certain length of time.

Setting the Clock

The timers depend on the clock: the clock must be right for the timers to work as you expect.

You can set the clock whether the unit is on or off.

Note that the clock must be set, or the timers cannot be set.

CLOCK
/TIMER



- 1. Press the CLOCK/TIMER button until the clock indication appears and the hour digits starts flashing on the display.**

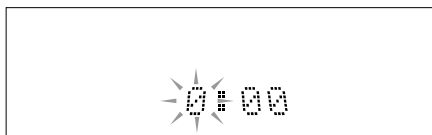

(Continued to the next page)

□ Each time you press the button, the Clock/Timer setting mode changes as follows:

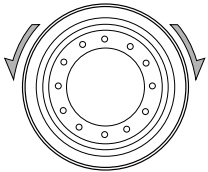
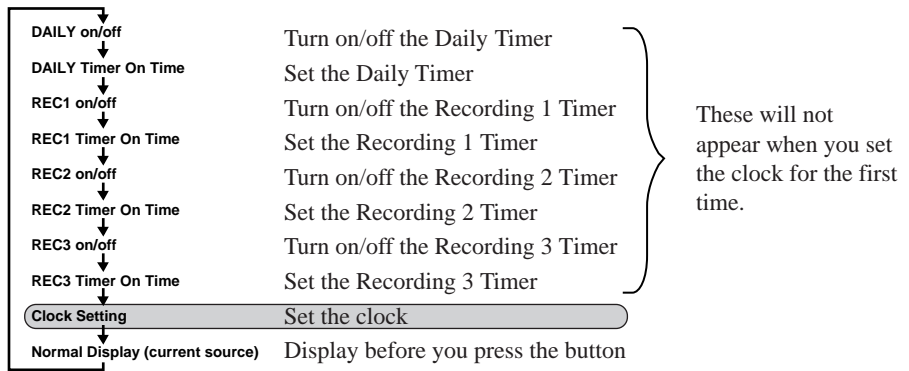

MULTI JOG

2. Rotate the MULTI JOG dial clockwise or counterclockwise to adjust the hour.

Rotate the MULTI JOG dial clockwise to advance the hour setting, rotate it counterclockwise to decrease the setting.



3. Press the SET button.

The minute digits starts flashing on the display.

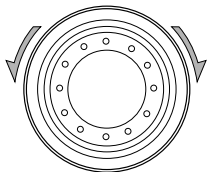

MULTI JOG

4. Rotate the MULTI JOG dial clockwise or counterclockwise to adjust the minute.

Rotate the MULTI JOG dial clockwise to advance the minute setting, rotate it counterclockwise to decrease the setting.



5. Press the SET button.

The clock starts at zero seconds from the set time.

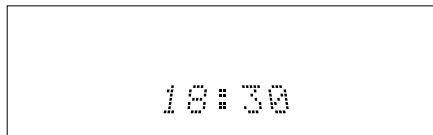

Note:

If you press any other button than the specified ones while setting the clock, the procedure will be canceled and you will have to restart from the beginning.

CAUTION: If there is a power failure, the clock loses its setting. The clock becomes "0:00", and the clock must be reset.

Setting the Daily Timer

With this timer you can wake up to music from a CD, a MD, a tape, your favorite radio program, or the external source.

- You can set the Daily Timer whether the unit is on or off.
- If the clock has not been set, you cannot select the Daily Timer.

CLOCK
/TIMER



Procedure for Setting the Daily Timer

- 1. Press the CLOCK/TIMER button repeatedly until the Daily Timer On-Time setting mode is selected.**
The DAILY indicator starts flashing on the display.



- Each time you press the button, the Clock/Timer setting mode changes as follows:

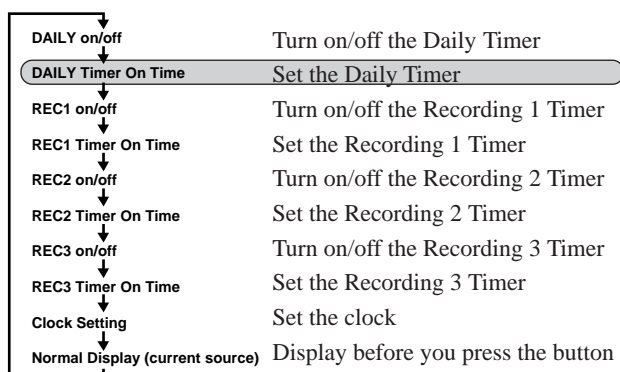

- 2. Set the time you want the unit to turn on.**

1. Rotate the MULTI JOG dial to select the hour, then press the SET button.
2. Rotate the MULTI JOG dial to select the minute, then press the SET button.

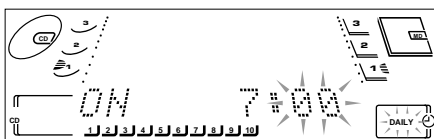
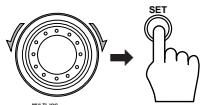

- 3. Set the time you want the unit to turn off.**

1. Rotate the MULTI JOG dial to select the hour, then press the SET button.
2. Rotate the MULTI JOG dial to select the minute, then press the SET button.

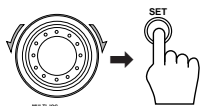

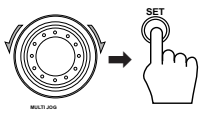

4. Select the source you want to listen to.

1. Rotate the MULTI JOG dial clockwise or counterclockwise until the source you want appears on the display.

The selected source changes as follow:

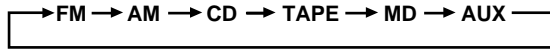

2. Press the SET button to enter the source.

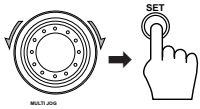

5. If you have selected CD or MD as the source in step 4, select a disc to play.

1. Rotate the MULTI JOG dial clockwise or counterclockwise to select a disc.
2. Press the SET button.

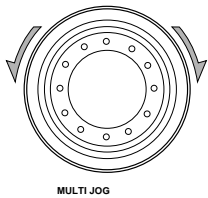

6. Set the Volume Level.

Rotate the MULTI JOG dial clockwise or counterclockwise to set the volume level.



Display	Volume Level
VOLUME —	Current volume level
VOLUME A	VOLUME 5
VOLUME B	VOLUME 12
VOLUME C	VOLUME 20



7. Press the SET button.

The DAILY indicator stops flashing and remains lit. The contents of the timer setting will be shown on the display for a while.

8. Turn the power off if you set the timer with the power turned on.

- ❑ A few seconds before the on-time, the CA-MD9R automatically turns on the power, and “DAILY TIMER” starts flashing on the display. When the on-time comes, playback starts using the selected source. When the off-time comes, the power is automatically turned off.



Before Turning Off the unit

- If you have selected “FM” or “AM” as the source, make sure that the station you want is selected.
If not, select the station you want.
- If you have selected “CD” or “MD,” make sure that you have prepared a CD or an MD.
- If you have selected “TAPE” as the source:
 - Make sure that there is a tape in the cassette holder.
 - Check that the tape direction is correct. This is important especially when the auto reverse mode is off.
 - Set the auto reverse mode on if you want to play both sides of the tape.
- Select the Sound Mode if you want to listen using a Sound Mode.

To change the Daily Timer setting

To change the settings for the Daily Timer, repeat the setting procedure from the beginning.

Turning the Daily Timer On and Off _____

Once the Daily Timer has been set it will be activated at the same time every day until the setting is turned off.

To turn the Daily Timer off, press the CLOCK/TIMER button repeatedly until “DAILY on/off” appears on the display. Press the CANCEL button, “on” disappears from the display and the DAILY indicator goes off.

To turn the Daily Timer on again, press the CLOCK/TIMER button until “DAILY on/off” appears on the display, then press the SET button. The contents of the Daily Timer setting are shown on the display.

CAUTION: If the CA-MD9R is unplugged, or a power failure occurs, the timer setting will be erased in a few days. If the settings are erased, reset the timer settings.

Setting the Recording Timer

With the Recording Timer you can record a radio broadcast automatically whether or not you are home.

- You can set the Recording Timer whether the unit is on or off.
- You can set three different Recording Timer settings (REC 1 to 3).
- If the clock has not been set, you cannot select the Recording Timer.

Procedure for Setting the Recording Timer

CLOCK
/TIMER



1. Press the **CLOCK/TIMER** button repeatedly until Recording timer on-time setting mode appears on the display.

The REC 1, 2 or 3 indicator also lights up on the display.

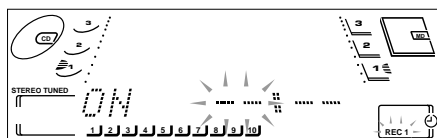

- Each time you press the button, the Clock/Timer setting mode changes as follows:

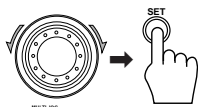
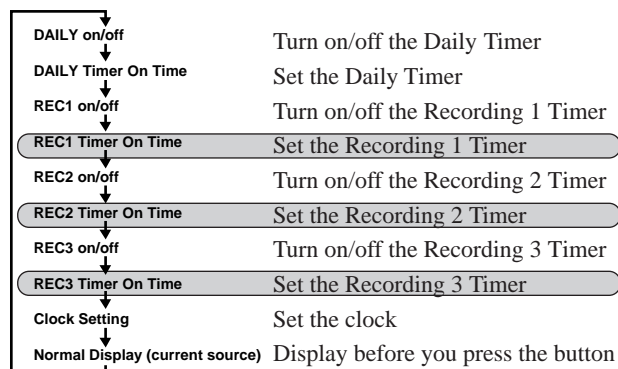

2. Set the time you want the unit to be turned on.

1. Rotate the MULTI JOG dial to select the hour, then press the SET button.
2. Rotate the MULTI JOG dial to select the minute, then press the SET button.

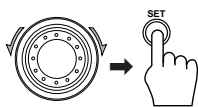
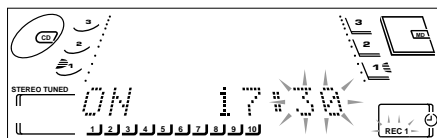

3. Set the time you want the unit to be turned off.

1. Rotate the MULTI JOG dial to select the hour, then press the SET button.
2. Rotate the MULTI JOG dial to select the minute, then press the SET button.



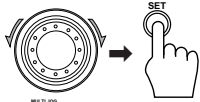

4. Select a preset station you want to record.

1. Rotate the MULTI JOG dial to select a preset station.
2. Press the SET button to enter the preset station.



5. Select the recording equipment.

The recording equipment changes as follows:

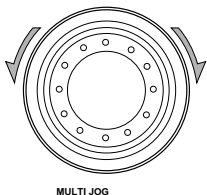

- TAPE : To record on the tape.
- MD 1 : To record on the MD 1.
- MD 2 : To record on the MD 2.
- MD 3 : To record on the MD 3.
- MD ALL : To record on all the three MDs.



6. Press the SET button.

The REC (1 to 3) indicator stops flashing and remains lit. The contents of the Recording Timer setting are shown on the display for a while.

7. Press ϕ/I to turn the power off if necessary.

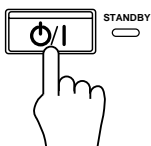

- A few seconds before the on-time, the CA-MD9R automatically turns on the power, and “REC (1 to 3) TIMER” flashes on the display. When the on-times comes, recording starts using the selected recording equipment. When the off-times comes, the power is automatically turned off again.

Before Turning Off the unit

- Check that tape direction is correct when recording on a tape. This is important especially when the auto reverse mode is off.
- Set the auto reverse mode on if you want to record on both sides of the tape.
- Check that an MD is inserted in the selected slot(s).
- The VOLUME control is automatically set to 0 when Recording Timer starts recording.

To change the recording timer setting

To change the settings for the Recording Timer, repeat the setting procedure from the beginning.

Turning the Recording Timer On and Off

Once the Recording Timer has been used to record a source, the setting is maintained but the Timer is turned off.

To turn the Recording Timer off, press the CLOCK/TIMER button repeatedly until “REC on/off” appears in the display, then press the CANCEL button. “on” disappears from the display and the REC indicator goes off.

To turn the Recording Timer on again, press the CLOCK/TIMER button repeatedly until “REC on/off” appears on the display, then press the SET button. The contents of the Recording Timer settings are shown on the display for a while.

CAUTION: If the CA-MD9R is unplugged, or a power failure occurs, the timer setting will be erased in a few days. If the settings are erased in this way, reset the timer settings.

Setting the Sleep Timer

By setting this timer, you can fall asleep to music.

- ❑ You can only set the Sleep Timer when the unit is on.

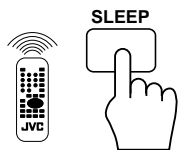

Procedure for Setting the Sleep Timer

1. While playing a source, press the SLEEP button on the Remote Control.

“SLEEP” appears on the display.

2. Press the SLEEP button repeatedly to set the length of time you want the source to play before shutting off.

- ❑ Each time you press this button while the “SLEEP” indicator is flashing, the number of minutes shown on the display change as follows:

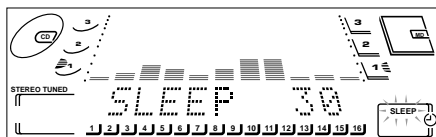
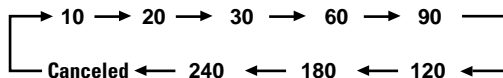

When the number of minutes you want is shown on the display, wait 5 seconds until the SLEEP indicator stops flashing and remains lit.

The unit is now set to turn off after the number of minutes you set.

To change the Sleep Timer setting

Press the SLEEP button repeatedly until the number of minutes you want appears on the display.

To cancel the Sleep Timer setting

Press the SLEEP button repeatedly until the SLEEP indicator goes off on the display.

Turning off the unit also cancels the Sleep Timer.

Timer Priority

Since each timer can be set independently, you may wonder what happens if the settings overlap. Here are the priorities for each timer:

- ❑ If the Recording Timer is set to come on while another timer is operating, the other timer will shut off 10 seconds before the Recording Timer is set to turn on, and the Recording Timer will then take over. (Example 1)
- ❑ If two Recording Timers overlaps, the one with a late on-time has the priority. (Example 2)
- ❑ The Sleep Timer has the priority over the Daily Timer. This means that if the Sleep Timer is set while the Daily Timer is operating, the Sleep Timer will take over. (Example 3)
- ❑ If you set the Sleep Timer while the Recording Timer is operating, the Recording Timer will be canceled, but recording continues.

Example 1

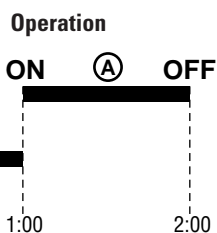
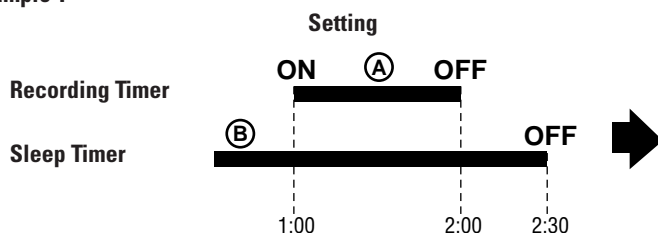

The Recording Timer has priority.
The sound is cut off a few seconds before the Recording Timer on-time.

Example 2

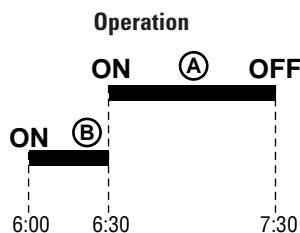
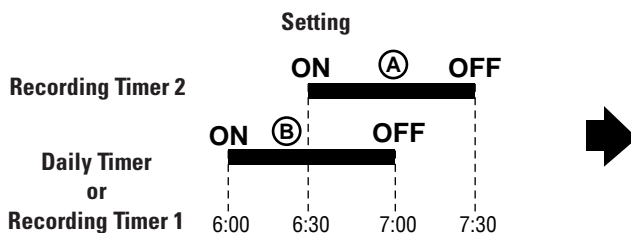

The Recording Timer 2 has priority.
The sound is cut off a few seconds before the Recording Timer on-time.

Example 3

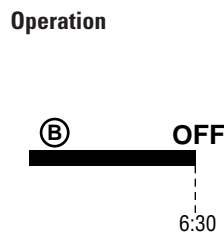
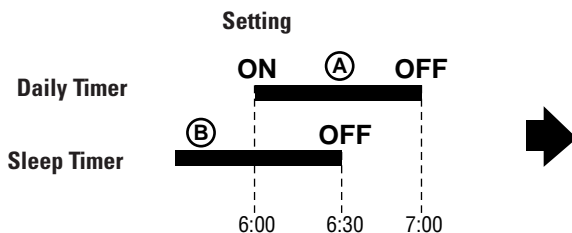





The Sleep Timer has priority.

When the Disc Lock function is on, the CD trays and MD loading slot cover cannot be opened even if you press the ▲ button.

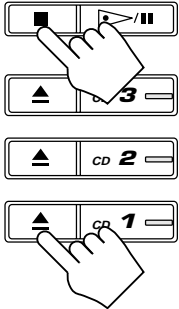
This function can only be possible by using the buttons on the unit.



Locking the Discs



1. Press the  button to turn off the unit (in standby mode).
2. While pressing the  button, press the  button for CD1 tray.
“LOCKED” appears on the display, and discs are “locked.”

If you press the  buttons while the discs are “locked,” “LOCKED” will appear on the display.

Unlocking the Discs

1. Press the  button to turn off the unit (in standby mode).
2. While pressing the  button, press the  button for CD1 tray.
“UNLOCKED” appears on the display, and discs are “unlocked.”

Care and Maintenance

General Notes

In general, you will have the best performance by keeping your tapes, CDs, MDs and the mechanism clean.

- Store tapes, CDs and MDs in their cases, and keep them in cabinets or on shelves.
- Keep the cassette holder, the CD trays, and the MD loading slot cover closed when not in use.

Compact Discs



- Remove the CD from the case by holding it at the edges while pressing the center hole lightly.
- Do not touch the shiny surface of the CD, or bend the CD.



- Be careful not to scratch the surface of the CD when placing it back in the case.
- Avoid exposure to direct sunlight, temperature extremes, and moisture.



- A dirty CD may not play correctly. If a CD does become dirty, wipe it with a soft cloth in a straight line, from center to edge.

CAUTION: Do not use any solvent (for example, conventional record cleaner, spray thinner, benzine, etc.) to clean a CD.

Mini Discs

- Do not open the shutter.
 - The shutter is locked so that it will not open. Trying to force it open will break the disc. If the shutter opens accidentally, close it again quickly without touching the disc inside.
- Do not place discs in the following places:
 - High temperatures areas such in direct sunlight or inside a car.
 - High humidity areas, e.g. in a bathroom.
 - On a beach or sandy area.
- Clean discs regularly.
 - If dust or dirt gets on cartridge, wipe it off with a soft dry cloth.

Moisture Condensation



Moisture may condense on the lens inside the unit in the following cases:

- After starting the heating in the room.
- In a damp room.
- If the unit is brought directly from a cold to a warm place.

Should this occur, the unit may malfunction. In this case, leave the unit turned on for a few hours until the moisture evaporates, unplug the AC power cord, and then plug it in again.

Cassette Tapes

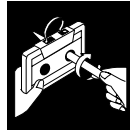

- If the tape is loose in its cassette, take up the slack by inserting a pencil in one of the reels and rotating.
- If the tape is loose, it may get stretched, cut, or caught in the cassette.

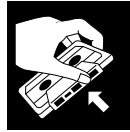

- Do not touch the tape surface.

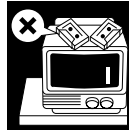

- Do not store the tape:
 - In dusty places
 - In direct sunlight or heat
 - In moist areas
 - On a TV or speaker
 - Near a magnet

Cassette Deck

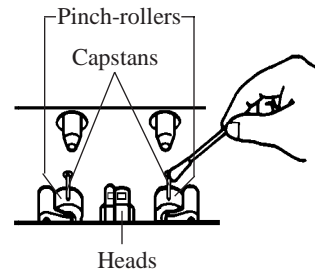

- If the heads, capstans, and pinch-rollers of the Cassette Deck become dirty, the following will occur:
 - Loss of sound quality
 - Discontinuous sound
 - Fading
 - Incomplete erasure
 - Difficulty recording
- Clean the heads, capstans, and pinch-rollers using a cotton swab moistened with alcohol.



- If the heads become magnetized, the unit will produce noise or lose high frequencies.
- To demagnetize the heads, turn off the unit, and use a head demagnetizer (available at electronics and record shops).

Troubleshooting

- If you are having a problem with your CA-MD9R, check this list for a possible solution before calling for service.
- If you cannot solve the problem from the hints given here, or the unit has been physically damaged, call a qualified person, such as your dealer, for service.

Symptom	Possible Cause	Action
No sound is heard.	Connections are incorrect, or loose.	Check all connections and make corrections. (See pages 4 – 5.)
Unable to record on an MD.	<ul style="list-style-type: none"> • You are using a prerecorded MD. • The MD is write-protected. 	<ul style="list-style-type: none"> • Change it with a recordable MD. • Unprotect the MD. (See page 69.)
Unable to record.	Cassette record protect tabs are removed.	Cover holes on back edge of cassette with adhesive tape.
Poor radio reception.	<ul style="list-style-type: none"> • The antenna is not connected correctly. • The AM loop antenna is too close to the unit. • The FM antenna is not properly extended and positioned. 	<ul style="list-style-type: none"> • Reconnect the antenna securely. • Change the position and direction of the AM loop antenna. • Extend FM antenna to the best reception position.
The CD skips.	The CD is dirty or scratched.	Clean or replace the CD.
Unable to operate the Remote Control.	<ul style="list-style-type: none"> • The path between the Remote Control and the sensor on the unit is blocked. • The batteries have lost their charge. 	<ul style="list-style-type: none"> • Remove the obstruction. • Replace the batteries.
The CD trays or MD loading slot cover cannot be opened.	<ul style="list-style-type: none"> • The main AC power cord is not plugged in. • The Disc Lock function is turned on. 	<ul style="list-style-type: none"> • Plug in the AC power plug. • Turn off the Disc Lock function. (See page 66.)
The CD does not play.	The CD is upside down.	Put the CD in with the label side up.
Operations are disabled.	The built-in microprocessor has malfunctioned due to external electrical interference.	Unplug the unit then plug it back in.
The cassette holder cannot be opened.	During tape playing, the power cord was unplugged.	Plug in the power cord, press the  button, then the  button.

MD Error Messages

Error Message	Signification	Solution
BLANK DISC	The disc is blank.	Change the disc with another if you want to enjoy playback.
CANNOT JOIN	You are trying to join tracks which cannot be joined.	This is not a malfunction. (See MD limitations.)
DISC ERROR	There is a problem with this disc.	Change the disc.
DISC FULL	There is no more space on the disc or there are over 254 tracks.	Use another recordable MD or erase some tracks.
EMERGENCY STOP	A malfunction occurs during the recording.	Eject the MD and re-insert it.
MD NO DISC	There is no disc.	Put an MD.
NON-AUDIO CANNOT COPY	You are trying to copy a non-audio disc like a CD-ROM or a Video CD.	Stop the recording.
PLAYBACK MD	You are trying to edit or record a playback-only MD	Use a recordable MD for recording.
DISC PROTECTED	The disc is write-protected.	Unprotect the disc or use another.
TRACK PROTECTED	The track is protected using another MD recorder.	Press the SET button, then the EDIT button to cancel the track protection.
OCCUPIED	During playback, you inserted an MD into the loading slot where another MD has been inserted.	Remove the MD.
LOAD ERROR	The MD is not inserted correctly.	Insert the MD correctly then press the  button for the MD Recorder.

MD limitations

The MD records data in an original format that differs from that of conventional cassette tapes or DATs. Since there are some limitations with this recording format, the following types of symptoms may occur. These symptoms are not malfunctions.

Symptoms	Cause
“DISC FULL” appears, even though there is still enough remaining time on an MD.	There is a maximum number of tracks which can be recorded, regardless of time. More than 254 tracks cannot be recorded on a disc.
“DISC FULL” appears even though the number of tracks and recording time do not reach the limit.	<ul style="list-style-type: none"> Repeating erasure and recording on the same disc create many blank portions sparsely on the disc. When recording on such a disc, a track is recorded on these blank portions sparsely. If a track is divided and recorded into so many portions, “DISC FULL” appears. If a divided portion of less than 8 seconds is made while a track is recorded on the MD, that track cannot be joined to another track using the JOIN function. Furthermore, if that track is erased, the remaining time of the MD may not increase exactly by the erased amount. If a track has been divided into many portions while being recorded on the MD, sounds will drop out while fast forwarding or reversing such an MD.
The JOIN function sometimes does not work.	
The remaining time on the disc does not increase even when tracks are erased.	
The sound drops out during fast forward or fast rewind.	
The amount of recorded time on the disc added to the amount of remaining time is shorter than the disc’s total possible recording time.	You cannot record on a blank portion of less than 2 seconds in the MD. For this reason, the actual recording time of discs may become shorter.

Specifications

Amplifier Section

Output Power (IEC 268-3/DIN)	37 watts per channel, min. RMS, both channels driven, into 6 ohms at 1 kHz with no more than 0.9% total harmonic distortion.
Input Sensitivity/Impedance (1 kHz)	
AUX	400 mV/47 kohms
Speaker terminals	
Main speakers	6 – 16 ohms

Tuner Section

FM Tuner	
Tuning Range	87.5 – 108.0 MHz
AM Tuner	
Tuning Range	
MW	522 – 1,629 kHz
LW	144 – 288 kHz

Timer Section

Rec Timer	1 min. to 23 hours 59 min.
Daily Timer	1 min. to 23 hours 59 min.
Sleep Timer	10 min. to 240 min.
Clock Display	24 hours cycle display

Cassette Deck Section

Frequency Response	
Type II (CrO ₂) :	30 – 16,000 Hz
Type I (NORMAL) :	30 – 15,000 Hz
Wow And Flutter	0.15% (WRMS)

CD Automatic Changer Section

CD Capacity	3 CDs
Dynamic Range	94 dB
Signal-To-Noise Ratio	100 dB
Wow And Flutter	Unmeasurable

MD Automatic Changer Section

Audio Playing System	MiniDisc digital audio system
Recording System	Magneto-optical overwrite system
Reading System	Non-contact, semiconductor laser pick-up ($\lambda = 780\text{nm}$)
Error correction System	CIRC (Cross Interleave Reed-Solomon Code)
Sampling frequency	44.1 kHz
Audio compression System	ATRAC (Adaptive TRansform Acoustic Coding)
Number of channels	2
Wow And Flutter	Unmeasurable

General

Dimensions	245 x 345 x 346.5 mm (W/H/D) (9-11/16 x 13-5/8 x 13-5/8 inches)
Mass	9.5 kg (20.9 lbs)

Accessories

AM (MW/LW) Loop Antenna	(1)
Remote Control	(1)
Batteries R6P (SUM-3)/AA (15F)	(2)
FM Wire Antenna	(1)

Power Specifications

Power Requirements	AC 230 V \sim , 50 Hz
Power Consumption	110 watts 15 watts (in standby mode)

Design and specifications are subject to change without notice.

Some Words about MDs

There are two types of MDs: premastered (prerecorded) and recordable (blank).

Premastered MDs

Premastered MDs, which have been recorded at music studio, can be played back like regular CDs. On an MD of this type, data is recorded as the presence or absence of tiny pits. A laser beam focuses on the pits on the surface of the MD and reflects the detection back to the lens in the MD Recorder. The MD Recorder then decodes the signals and plays them back as music. This type of MD is called an “optical disc.”

Recordable MDs

Recordable MDs, which use magneto-optical technology, can be recorded and played back repeatedly. The laser inside the MD Recorder applies heat to the MD, demagnetizing the magnetic layer of the MD for recording and playback. This type of MD is called an “magnetic-optical disc.”

ATRAC (Adaptive TTransform Acoustic Coding)

The MD provides 74 minutes recording and playback time, the same as an audio CD, but in a diameter of only 64 mm. This ability to store such a large amount of data is the result of ATRAC, an audio compression technique developed for MD. This technology, cuts out faint sounds that would not be heard by the human beings. This technology, based on human sensitivity to sounds, enabled the recorded data to be about one-fifth of the original data.

UTOC (User Table Of Contents)

Found only on recordable MDs, this area contains sub-data (track number, recording data etc.) which can be rewritten by the user.

UTOC enables us to search tracks quickly and edit tracks on the MD.

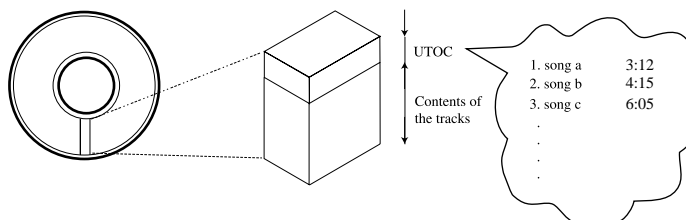

Serial Copy Management System (SCMS)

The MD Recorder integrated to this unit uses the Serial Copy Management System which allows only first-generation digital copies to be made of premastered software (like CDs or prerecorded MDs).

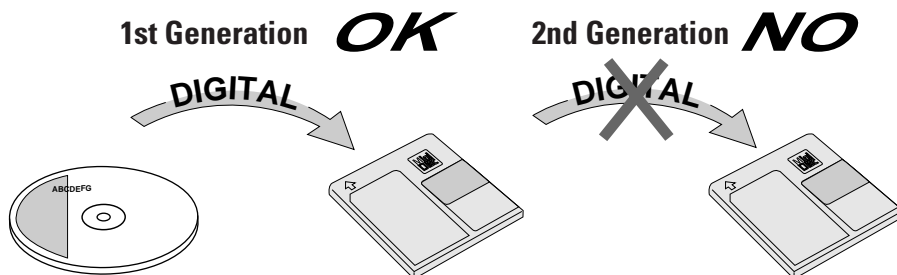

Sound Skip Guard Memory

The biggest weakness of discs is their susceptibility to vibration. The “Sound Skip Guard Memory” has been developed to cope with this weakness.

With this function, a few seconds of signals read by the optical read head from the disc are first stored in memory before being reproduced as audio signals. Thus, even when vibration or shock interrupts signals being read, these stored signals can continue to reproduce sounds for the few seconds. Thus, the user will enjoy uninterrupted music.

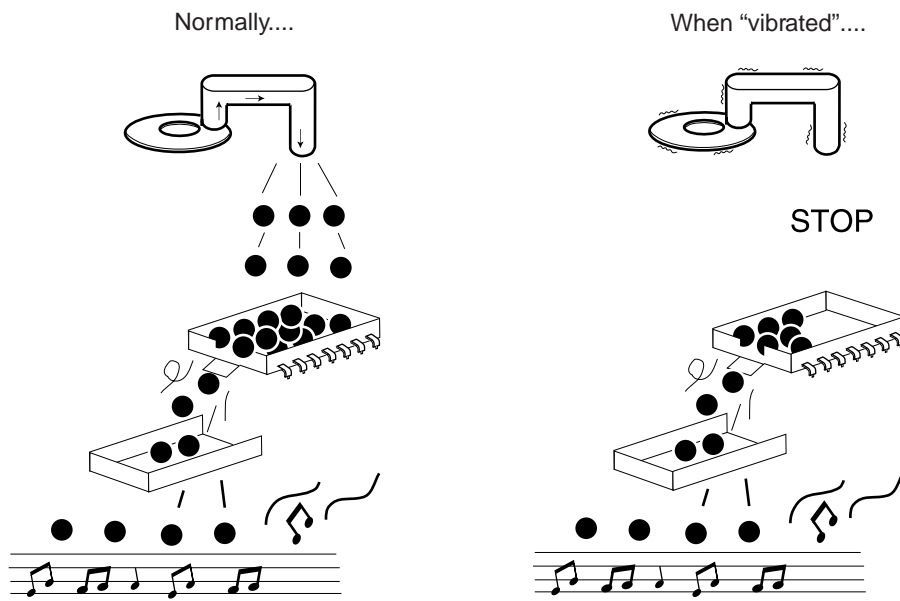

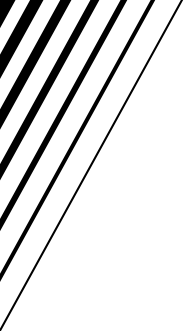

JVC
VICTOR COMPANY OF JAPAN, LIMITED